



HANDY WITH FACILITY



VI





SHOWROOM

## INTRODUCTION

Harden Tools Co., Ltd. is a leading company, which specializes in the manufacturing, product development, sales and service of hardware tools and devotes itself to providing industrial level hardware tools with high cost-performance ratio. After years of development, we have business partners in more than 50 countries, with offices for R/D and sales in Germany, etc. Nowadays, and "HARDEN" brand have grown up to be the first choice for customers in china local market and abroad, becoming their trustworthy partners.

Thanks to our professional management team, we always produce and control the quality according to the standard of "DIN" and "ISO". We have imported advanced testing equipments, thus offering strong supports for Fatigue Testing of some products. We have independently studied, developed and worked out our own shear testing equipment, which has effectively tested the cutting life of pliers. All these and other purchased or self-made testing equipments have provided and will always provide effective guarantee for and "HARDEN" brand products.

Our company has signed a strategic cooperation agreement with China National Industrial Tool & Hardware Quality Supervision & Test Shanghai station, which conduct the regular inspection and the random sample test of our products. Thus, customers could always get good quality products from us.

Our vision: To be a customer-oriented company in the industrial support and service line.

Our quality: Quality is the foundation of brand. 1% oversight of quality means 100% dereliction of duty to customers.

Our ideal: Act with honesty; Responsibility first; Perfect details, Innovation and development.





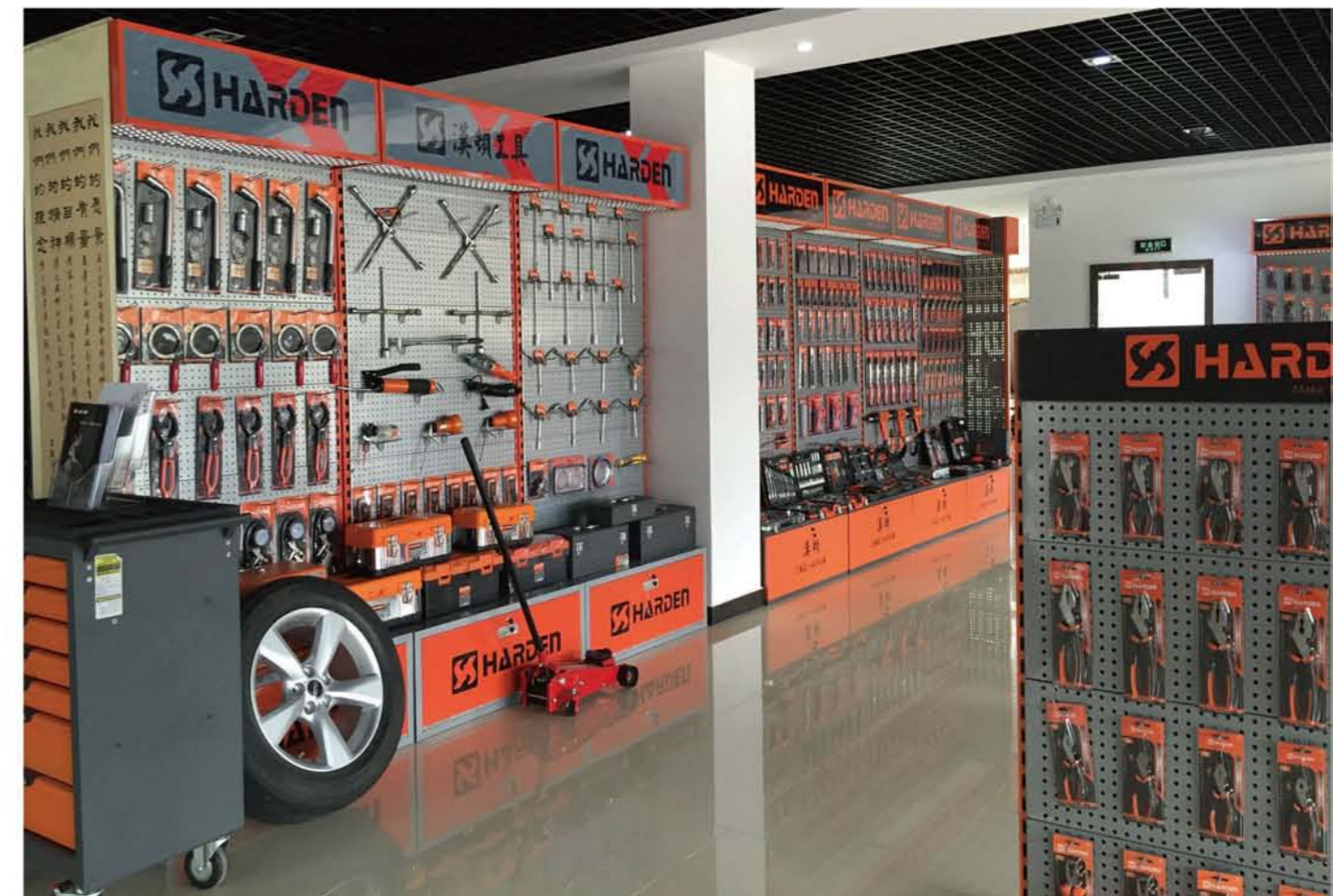



Our spirit: God reward those who work hard. Honesty makes good business. We are honesty, diligent and pragmatic.

Our goal: To please customers by service; To attract staff by consideration; To reward partners by value; To return society by harmony.

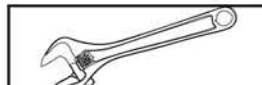
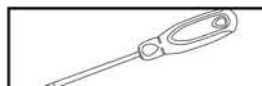

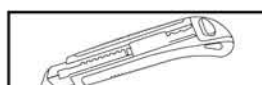
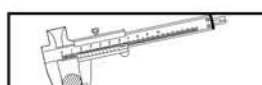

# 19 CATEGORIES CONTENTS

	<b>01 TOOLS SET</b>	<b>05-10</b>
	<b>02 TOOLS BOX TOOLS BAG TOOLS CABINET</b>	<b>11-16</b>
	<b>03 SOCKETS &amp; ACCESSORIES</b>	<b>17-22</b>
	<b>04 SPANNER TOOLS</b>	<b>23-30</b>
	<b>05 FASTENING TOOLS</b>	<b>31-39</b>
	<b>06 PLIER &amp; CLAMPING TOOLS</b>	<b>40-48</b>
	<b>07 CUTTING TOOLS</b>	<b>49-55</b>
	<b>08 MEASURE TOOLS</b>	<b>56-60</b>
	<b>09 STRIKING TOOLS</b>	<b>61-66</b>
	<b>10 PLUMBING TOOLS</b>	<b>67-70</b>
	<b>11 TRIMMING TOOLS</b>	<b>71-86</b>
	<b>12 DECORATION TOOLS</b>	<b>87-95</b>
	<b>13 GARDEN TOOLS</b>	<b>96-101</b>
	<b>14 ELECTRONIC TOOLS</b>	<b>102-110</b>
	<b>15 AUTO TOOLS</b>	<b>111-115</b>
	<b>16 AIR TOOLS</b>	<b>116-117</b>
	<b>17 HYDRAULIC TOOLS</b>	<b>118-119</b>
	<b>18 POWER TOOLS</b>	<b>120-128</b>
	<b>19 SAFETY TOOLS</b>	<b>129-132</b>

# TOOLS SET



## 13Pcs 1/4" Socket Sets

### ★ INTRODUCTION



- \* Material: High quality Chrome Vanadium
- \* 1Pc 1/4" Quick Release Ratchet Spanner
- \* 1Pc Extension Bar 1/4"x2"
- \* 11Pcs 6pt Socket: 4,5,6,7,8,9,10,11,12,13,14MM



ITEM NO	PCS	BARCODE
510013	24	6959820800014

## 13Pcs 3/8" Socket Sets

### ★ INTRODUCTION



- \* Material: High quality Chrome Vanadium
- \* 1Pc 3/8" Quick Release Ratchet Spanner
- \* 1Pc Extension Bar 3/8"x3"
- \* 11Pcs 6pt Socket: 8,9,10,11,12,13,14,15,16,17,19MM



ITEM NO	PCS	BARCODE
510015	24	6959820800021

## 12Pcs 1/2" Socket Sets

### ★ INTRODUCTION



- \* Material: High quality Chrome Vanadium
- \* 1Pc 1/2" Quick Release Ratchet Spanner
- \* 1Pc Extension Bar 1/2"x5"
- \* 10Pcs 6pt Socket: 10,12,13,14,15,16,17,19,22,24MM



ITEM NO	PCS	BARCODE
510016	12	6959820800038

## 46Pcs 1/4" Dr. Socket Set

### ★ INTRODUCTION



- \* Chrome Vanadium steel forged
- \* Widely used in mining, metallurgy, shipbuilding, electric power and automobile industry and so on Including the following products:
- \* 1pc 1/4" Dr. Flipper ratchet
- \* 4pcs Flat head hex key wrench:1.5,2,2.5,3mm
- \* 13pcs 1/4" Dr. socket:4,4.5,5,5.5,6,7,8,9,10,11,12,13,14mm
- \* 2pcs 1/4" Dr. Extension rod:2",4"
- \* 21pcs Bit sockets:(Torx: T10,T15,T20,T25,T30,T40;Hex:H3,H4,H5,H6,H7,H8mm;Phillips:PH1,PH2,PH3;Pozi:PZ1,PZ2,PZ3; Slotted:4,5,5.7mm)
- \* 1pc 1/4" Dr. Handle
- \* 1pc 1/4" Dr. AD
- \* 1pc 1/4" Dr. Slider100mm
- \* 1pc 1/4" Dr. Universal socket
- \* 1pc 1/4" Bent joint



ITEM NO	PCS	BARCODE
510346	10	6959820800311

## 32Pcs 1/2" Dr. Socket Set

### ★ INTRODUCTION



- \* Chrome Vanadium steel forged
- \* Widely used in mining, metallurgy, shipbuilding, electric power and automobile industry and so on Including the following products:
- \* 19pcs 1/2" Dr.Hex sockets:8,9,10,11,12,13,14,15,16,17,18,19,20,21,22,24,27,30,32mm
- \* 6pcs 1/2" Dr.Bihexagonal sockets:10,12,14,15,17,19mm
- \* 2pcs 1/2" Dr.Spark plug socket:16mm,21mm
- \* 1pc 1/2" Dr. Universal joint
- \* 2pcs 1/2" Dr.Extension rod:5",10"
- \* 1pc 1/2" Dr. Flipper ratchet
- \* 1pc 1/2" Dr. Three way joint



ITEM NO	PCS	BARCODE
510432	4	6959820800335

**77Pcs 1/2" & 1/4" Dr. Socket Set**

★ **INTRODUCTION**

- \* Chrome Vanadium steel forged
- \* Widely used in mining, metallurgy, shipbuilding, electric power and automobile industry and so on including the following products:
- \* 9pcs 1/4" Dr.Hex sockets:5,6,7,8,9,10,11,12,13mm
- \* 1pc 1/4" Dr.Flipper ratchet
- \* 1pc 1/4" Dr.Universal joint
- \* 1pc 1/4" Dr.Sliding T bar:110mm
- \* 1pc 1/4" Dr.Extension rod :3"
- \* 1pc 1/4" Dr.Bit adapter
- \* 2pcs 1/2" Dr.Extension rod:5",10"
- \* 1pc 1/2" Dr.Spark plug socket:21mm
- \* 13pcs 1/2" Dr.Hex sockets:10,11,12,13,14,15,17,19,22,24,27,30,32mm



- \* 1pc 1/2" Dr.Flipper ratchet
- \* 1pc 1/2" Dr. Universal joint
- \* 22pcs 25mm Bits: Hex:H3,H4,H5,H6;Slotted:3,4,5,6,7mm;Phillips:PH1,PH2,PH3;Pozi:PZ1,PZ2,PZ3;Torx:T10,T15,T20,T25,T27,T30,T40
- \* 8pcs Flat head hex key wrench:1.5,2.2,5,3,4,5,5.5,6mm
- \* 11pcs Combination wrench:8,9,10,11,12,13,14,15,16,17,19mm
- \* 4pcs Two head adjustable socket wrench:8\*9mm,10\*11mm,12\*13mm,14\*15mm
- \* 1pc Blow case



ITEM NO	PCS	BARCODE
510677	3	6959820800342

**94Pcs 1/2" & 1/4" Dr. Socket Set**

★ **INTRODUCTION**

- \* Chrome Vanadium steel forged
- \* Widely used in mining, metallurgy, shipbuilding, electric power and automobile industry, etc.
- Including the following products:
- \* 13pcs 1/4" Dr. Hex sockets:4,4.5,5,5.5,6,7,8,9,10,11,12,13,14mm
- \* 8pcs 1/4" Dr.Hex deep sockets:6,7,8,9,10,11,12,13mm
- \* 2pcs 1/4" Dr. Extension rod:2",4"
- \* 1pc 1/4" Dr. Flexible socket joint:150mm
- \* 1pc 1/4" Dr. Universal joint
- \* 1pc 1/4" Dr. Spinner handle
- \* 1pc 1/4" Dr. Sliding T bar:110mm
- \* 1pc 1/4" Dr. Socket extension:30mm
- \* 1pc 1/4" Dr. Flipper ratchet handle
- \* 4pcs 1/2" Dr. Hex deep sockets:14,15,17,19mm



- \* 17pcs 1/4" Dr. Bit sockets: Hex:H3,H4,H5,H6mm;Slotted:4,5,5,7mm;Phillips:PH1,PH2; Pozi:PZ1,PZ2; Torx:T10,T15,T20,T25,T30
- \* 18pcs 1/2" Dr. Hex sockets:10,11,12,13,14,15,16,17,18,19,20,21,22,23,24,27,30,32mm
- \* 2pc 1/2" Dr. Extension rod :5",10"
- \* 2pc 1/2" Dr.Spark plug socket:16mm,21mm
- \* 1pc 1/2" Dr. Flipper ratchet handle
- \* 1pc 1/2"x3/8"Dr., 3 hole Way adapter
- \* 1pc 1/2" Dr. Universal joint
- \* 1pc 1/2" Dr. Hex bit adapter
- \* 4pcs Flat head Hex key wrench:1.5/2/2.5/3mm
- \* 15pcs 8x30mm Bits Hex :H8,H10,H12,H14mm;Slotted:8,10,12mm; Phillips:PH3,PH4;Pozi:PZ3,PZ4; Torx:T40,T45,T50,T55



ITEM NO	PCS	BARCODE
510694	3	6959820800359

**27Pcs 3/4" Dr.Socket Set**

★ **INTRODUCTION**

- \* Forged chrome vanadium
- \* Widely used in mining, metallurgy, shipbuilding, electric power and automobile industry and so on including the following products:
- \* 22Pcs-3/4" Dr.Bihexagonal Hex sockets:19,21,22,23,24,25,26,27,28,29,30,32,33,34,35,36,38,41,46,50,55,60mm
- \* 1Pc-3/4" Dr. Universal joint
- \* 2Pcs-3/4" Dr.Extension rod: 4"; 8"
- \* 1Pc-3/4" Dr. Slider 450mm
- \* 1Pc-3/4" Dr. Flipper ratchet



ITEM NO	PCS	BARCODE
510827	1	6959820853836

**77Pcs Tools Set**

★ **INTRODUCTION**

- \* 1Pc 1/2" dr.Ratchet Handle
- \* 1Pc 1/2" dr.Extension Bar
- \* 1Pc 6" Long Nose Plier
- \* 1Pc 6" Diagonal Cutter
- \* 1Pc 5M Tape Measure
- \* 1PC 10" Water Pump Plier
- \* 17Pc Screwdriver Bits(-)3,4,5,6,7mm, (+)PH1,PH2,PH3/PZ1,PZ2,PZ3/ T10,T15,T20,T25,T27,T30
- \* 8Pc Screwdriver:(-)3x75,4x100,5x125, 8x150,6x100mm;(+)PH2X100,PH1X75, PH3X150mm
- \* 12Pc Combination Spanner:8,10,11,12,13,14,15,16,17,18,19,22mm
- \* 9Pc Hex Key :1.5,2.2,5,3,4,5,6,8,10mm
- \* 1Pc Metal Tool Case
- \* 1Pc 1/2" Universal Joint
- \* 1Pc 1/2" dr.Sliding Bar 10"
- \* 1Pc 6 Combination Plier
- \* 1Pc Utility Knife
- \* 1Pc Utility Knife Blades 10Pcs
- \* 18Pc 1/2" dr.Socket:8,9,10,11,12,13,14, 15,16,17,18,19,20,21,22,24,27,30mm



ITEM NO	PCS	BARCODE
510777	1	6959820847514

**132Pcs 1/2" & 3/8" & 1/4" Dr. Socket Set**

★ **INTRODUCTION**

- \* Forged from chrome vanadium
- \* Widely used in mining, metallurgy, shipbuilding, electric power and automobile industry, etc.
- Including the following products:
- \* 7pcs 1/2" Dr. Hex sockets:20,21,22,24,27,30,32mm
- \* 11pcs 3/8" Dr. Hex sockets: 8,9,10,12,13,14,15,16,17,18,19mm
- \* 4pcs 3/8" Dr. Hex deep sockets:13,14,17,19mm
- \* 6pcs 3/8" Dr. Torx sockets: E8,E10,E11,E14,E16,E20mm
- \* 10pcs 1/4" Dr.Hex sockets:4,5,6,7,8,9,10,11,12,13mm
- \* 4pcs 1/4" Dr.Hex deep sockets:8,9,10,12mm
- \* 21pcs 1/4" Dr. Bit sockets: (Torx:T10,T15,T20,T25,T30,T40; Hex:3,4,5,6,7,8mm; Phillips:#1,#2,#3; Slotted:4,5,5,7,0mm; Pozi:#1,#2,#3)
- \* 3pcs Universal joint: 1/4" Dr. ,3/8"mm Dr. ,1/2" Dr.
- \* 1pc 1/4" Dr. Bit adapter
- \* 1pc 1/4" Dr. Bit handle
- \* 3pcs Dr.Spark plug socket: 1/2":16mm,21mm; 3/8":14mm(for Japanese car series)
- \* 11pcs Combination wrench: 8,9,10,11,12,13,14,16,17,18,19mm
- \* 1pc 1/4" Dr. Extension rod: 2"
- \* 2pcs 3/8" Dr. Extension rod: 3",6"
- \* 2pcs 1/2" Dr. Extension rod: 5",10"
- \* 3pcs Flipper ratchet handle: 1/4" Dr. ,3/8" Dr. ,1/2" Dr
- \* 2pcs Hose tap adapter: 3/8\*\*1/2"; 3/8\*\*1/4"
- \* 1pc Auto tester: 12-24V
- \* 2pcs 6x100mm striking screwdriver (slotted and philips)
- \* 9pcs Ball key wrench:1.5-10mm
- \* 1pc 1/2"Dr.,Bit socket T52,100mm length
- \* 1pc Three jaw oil filter wrench
- \* 1pc Socket for dismantling damper
- \* 1pc Hex socket H17 for dismantling screw
- \* 1pc Bihexagonal socket M16 for dismantling screw
- \* 1pc 300G Machinist hammer w fiberglass handle
- \* 22pcs Bits (Hex:3,4,5,6mm; Slotted:3,4,5,6,7mm; Phillips:#1,#2,#3; Pozi:#1,#2,#3; Torx:T10,T15,T20,T25,T27,T30,T40)



ITEM NO	PCS	BARCODE
510822	2	6959820800366

**36Pcs Multi-functional Impact Drill Set**

★ **INTRODUCTION**

- \* 1Pc Test Pencil:145mm
- \* 2Pcs Screwdriver:(Slotted)6X100mm, (Phillips)PH2X100mm
- \* 1Pc Bit Holder:6X100mm
- \* 3Pcs HSS Drill:4,5,6,8mm
- \* 3Pcs Masonry Drill:5,6,8,10mm
- \* 3Pcs Wood Drill:4,5,6,8mm
- \* 1Pc Knife:18mm
- \* 1Pc Torpedo Level:210mm
- \* 1Pc Working Accessories Box
- \* 1Pc Adjustable Wrench:200mm
- \* 11Pcs Bits Set
- \* 11Pcs Bits Set
- \* 1Pc Combination Plier:175mm
- \* 1Pc Claw Hammer:8OZ
- \* 1Pc Measuring Tape:3m\*19mm
- \* 1Pc PVC Insulating Tape:10m
- \* 1Pc Cordless Drill
- \* 1Pc 12V lithium battery
- \* 1Pc Battery charger
- \* 1pc Blow Case



ITEM NO	PCS	BARCODE
510836	4	6959820800427

**75Pcs Multi-functional Impact Drill Set**

★ **INTRODUCTION**

- \* 1Pc Mini Hacksaw:300mm
- \* 1Pc Test Pencil:145mm
- \* 2Pcs Screwdriver:(Slotted)6X100mm, (Phillips)PH2X100mm
- \* 1Pc Bit Holder:6X100mm
- \* 4Pcs HSS Drill:4,5,6,8mm
- \* 4Pcs Masonry Drill:5,6,8,10mm
- \* 4Pcs Wood Drill:4,5,6,8mm
- \* 1Pc Knife:18mm
- \* 10Pcs Knife Blade:18mm
- \* 4Pcs 1/4" Dr.Sockets:8,9,10,11mm
- \* 1Pc 1/4" Bit Adaptor
- \* 1Pc 1/4" Dr.Bit Holder:61mm
- \* 1Pc Torpedo Level:210mm
- \* 1Pc Working Accessories Box
- \* 1Pc Adjustable Wrench:200mm
- \* 1Pc Digital Multimeter
- \* 22Pcs Bits Set
- \* 1Pc Combination Plier:175mm
- \* 1Pc Water Pump Plier:250mm
- \* 1Pc Claw Hammer:8OZ
- \* 1Pc Measuring Tape:3m\*19mm
- \* 1Pc PVC Insulating Tape:10m
- \* 7Pcs Hex Key:1.5,2.2,5,3,4,5,6mm
- \* 1Pc Impact Drill:230V/550W 0-3000rpm
- \* 1Pc Impact Drill Handle
- \* 1Pc Impact Drill Key
- \* 1pc Blow Case



ITEM NO	PCS	BARCODE
510875	3	6959820800410

**18Pcs Repairing Tools Set**

★ **INTRODUCTION**

- \* 7Pcs Hex Key Wrench:1.5,2.2,2.5,3,4,5,6mm
- \* 2Pcs 2 In 1 Screwdriver:PH2/6mm\*100mm
- \* 1Pc Test Pencil:145mm
- \* 2Pcs Precision Screwdriver:(Slotted)3mm,(Philips)PH0,
- \* 1Pc Adjustable Wrench:200mm
- \* 1Pc Combination Plier:175mm
- \* 1Pc Measuring Tape:3m
- \* 1Pc Knife:18mm
- \* 1Pc Claw Hammer:8OZ
- \* 1Pc PVC Insulating Tape:10m



ITEM NO	PCS	BARCODE
511018	10	6959820849945

**22Pcs Repairing Tools Set**

★ **INTRODUCTION**

- \* 1Pc Stainless Steel Multi-purpose Scissors:200mm
- \* 8Pcs Hex Key Wrench:1.5,2.2,2.5,3,4,5,5.5,6mm
- \* 2Pcs 2 In 1 Screwdriver:PH2/6mm\*100mm
- \* 1Pc Test Pencil:145mm
- \* 4Pcs Precision Screwdriver:(Slotted)3mm,(Philips)PH0,(Torx)T8, FOR IPHONE:T3mm
- \* 1Pc Adjustable Wrench:200mm
- \* 1Pc Combination Plier:175mm
- \* 1Pc Measuring Tape:3m
- \* 1Pc Knife:18mm
- \* 1Pc Claw Hammer:8OZ
- \* 1Pc PVC Insulating Tape:10m



ITEM NO	PCS	BARCODE
510222	6	6959820800397

**39Pcs Repairing Tools Set**

★ **INTRODUCTION**

- \* 1Pc Mini Saw Bow:6"
- \* 6Pcs Saw Blade:6"
- \* 1Pc Electrical Tape:10m
- \* 1Pc Raw Material Tape
- \* 1Pc Utility Knife:18mm
- \* 1Pc Art Blade
- \* 1Pc Screwdriver:5\*100
- \* 1Pc Screwdriver:P1\*100
- \* 9Pcs 9-piece sleeve 5-13
- \* 1Pc Small square handle
- \* 2Pcs 2-piece clock and screwdriver
- \* 1Pc Wire cutter:6"
- \* 7Pcs 7-piece Hexagon:1.5,2.2,2.5,3,4,5,6mm
- \* 1Pc Two-color plastic handle claw hammer:8OZ/0.25KG
- \* 1Pc Long nose pliers:6"
- \* 1Pc Ordinary digital test pencil
- \* 1Pc tape measure:3mX16mm
- \* 1Pc Plastic adjustable wrench:8"
- \* 1Pc Parts box



ITEM NO	PCS	BARCODE
511039	5	6959820849952

**63Pcs Tools Set**

★ **INTRODUCTION**

- \* 4Pcs Precision Screwdriver
- \* 1Pcs Digital Display Tester:130mm
- \* 1Pcs Stainless Steel Scissors:200mm
- \* 2Pcs Screwdriver:(Slotted)5X100mm,(Philips)PH1X100mm
- \* 8Pcs Hex Key:1.5,2.2,2.5,3,4,5,6mm
- \* 1Pc Adjustable Wrench:200mm
- \* 1Pc Ratchet Handle
- \* 1Pc Water Pump Plier:250mm
- \* 1Pc PVC Insulating Tape:10m
- \* 1Pc Measuring Tape:3m\*19mm
- \* 1Pc Claw Hammer:8OZ
- \* 1pc combination plier:7"
- \* 1pc Long Nose plier:6"
- \* 1pc knife :18mm
- \* 10Pcs Knife Blade:18mm
- \* 1Pc 1/4" Bit Adaptor
- \* 1Pc Mini Hacksaw Frame:6"
- \* Mini Steel Blade
- \* 9Pc Dr.Socket
- \* 22Pcs Bits Set
- \* 1Pc PTFE Tape



ITEM NO	PCS	BARCODE
511012	3	6959820847293

**103Pcs Aluminum Toolkit Set**

★ **INTRODUCTION**

- \* 1Pc Flat Screwdriver 6x150mm
- \* 1Pc Phillips Screwdriver ph2x150mm
- \* 1Pc Stainless Steel Scissor
- \* 1Pc Soldering Wire
- \* 1Pc 2 in 1 Test Pencil
- \* 1Pc Ratchet Screwdriver
- \* 20Pcs Bits
- \* 1Pc Mini Hack Saw 6"
- \* 1Pc Water Tape
- \* 1Pc Flat type Precision Screwdriver
- \* 1Pc Phillips Precision Screwdriver
- \* 1Pc Torx Precision Screwdriver
- \* 1Pc Hex Precision Screwdriver
- \* 1Pc Soldering Iron 60W
- \* 1Pc Electric Insulation Tape
- \* 1Pc Measuring Tape3m
- \* 1Pc Wide Tweezer
- \* 1Pc Pointed Tweezer
- \* 7Pcs Hex Key Wrench Sets
- \* 1Pc Electricity Knife
- \* 1Pc Torch Light
- \* 50Pcs Spares Box
- \* 1Pc Combination Plier 8"
- \* 1Pc Long Nose Plier 6"
- \* 1Pc Water Pump Plier 10"
- \* 1Pc Claw Hammer with F/G Handle 16oz
- \* 1 Aluminium Case



ITEM NO	PCS	BARCODE
510703	3	6959820800373

**NEW SERIES OF PLASTIC CASE**



1

**Hex wrenches**  
Length lengthened, operating effort, high-quality high-carbon steel, head plus hardened, Twist twist is not deformed, durable.

Tools Set

2

**Electrical insulation tape**  
Made of polyvinyl chloride and stabilizers, not fade, with a high dielectric strength.



3

**Test pencil**  
Made of high-yin anti-natural mica heating core, heat-resistant handle, suitable for large area and wire and cable welding operations.

4

**Hacksaw Frame**  
An epoxy coated steel frame, supplied with a hardened and tempered blade which is ideal for small cutting in metal and wood.



5

**Screwdriver**  
Quality chrome vanadium steel, the overall heat treatment, toughness and torque, ergonomic TPR handle, feel comfortable and durable.





TOOLS BOX TOOLS BAG TOOLS CABINET

Hip Roof Tool Box

★ INTRODUCTION

- \* With electro static spraing and rust proof
- \* With heavy duty metal latches



ITEM NO	L mm	W mm	H mm	PCS	BARCODE
520101	355	155	90	1	6959820802018

Hip Roof Tool Box

★ INTRODUCTION

- \* With electro static spraing and rust proof
- \* With heavy duty metal latches

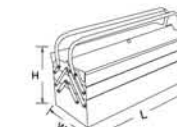

ITEM NO	L mm	W mm	H mm	PCS	BARCODE
520202	420	200	205	1	6959820802049

3 Drawer Chest

★ INTRODUCTION

- \* With electro static spraing and rust proof
- \* With heavy duty metal latches
- \* With smooth slides



ITEM NO	L mm	W mm	H mm	PCS	BARCODE
520204	532	221	286	1	6959820802063

Stainless Steel Tools Box

★ INTRODUCTION

- \* 0.8mm thickness stainless steel and ABS
- \* Special parts box for collecting



ITEM NO	L mm	W mm	H mm	PCS	BARCODE
520224	360	185	170	8	6959820802193
520226	410	215	183	6	6959820802209
520228	450	245	190	6	6959820802216

Hip Roof Tool Box

★ INTRODUCTION

- \* With electro static spraing and rust proof
- \* With heavy duty metal latches



ITEM NO	L mm	W mm	H mm	PCS	BARCODE
520102	430	180	190	1	6959820802025
520103	480	180	190	1	6959820802032

Tools Box

★ INTRODUCTION

- \* With electro static spraing and rust proof
- \* With heavy duty metal latches

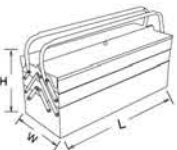

ITEM NO	L mm	W mm	H mm	PCS	BARCODE
520203	530	200	200	1	6959820849679

Plastic Tools Box

★ INTRODUCTION

- \* Transparent top for quick identification of contents
- \* Built-in removable tray optimizes space

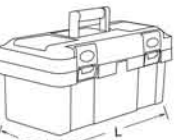

ITEM NO	L mm	W mm	H mm	PCS	BARCODE
520301	355	180	185	12	6959820802070
520302	400	210	190	9	6959820802087
520303	440	230	200	6	6959820802094

**Tools Bag**

★ INTRODUCTION

- \* Designed for sorting, taking away of different kind of tools
- \* Wear-resistant water-proof bag
- \* Improving work efficiency



ITEM NO	SIZE(mm)	PCS	BARCODE
520501	260X260	40	6959820802117

**Tools Vest**

★ INTRODUCTION

- \* Special design for sorting, taking away of different kind of tools
- \* Wear-resistant water-proof bag
- \* Improving work efficiency



ITEM NO	SIZE(mm)	PCS	BARCODE
520506	530x690mm	30	6959820802155

**Tools Bag**

★ INTRODUCTION

- \* Special design for sorting, taking away of different kind of tools
- \* Wear-resistant water-proof bag
- \* Improving work efficiency



ITEM NO	SIZE(mm)	PCS	BARCODE
520511	1200x125	30	6959820835351

**Tools Bag**

★ INTRODUCTION

- \* Designed for sorting, taking away of different kind of tools
- \* Wear-resistant water-proof bag
- \* Improving work efficiency



ITEM NO	SIZE(mm)	PCS	BARCODE
520502	400	20	6959820802124
520503	450	20	6959820802131
520505	500	20	6959820802148

**Tool Apron Oxford**

★ INTRODUCTION

- \* Made of high quality Oxford;
- \* Used for workshop



ITEM NO	PCS	BARCODE
520507	50	6959820802162

**3 Drawer Trolley**

★ INTRODUCTION

- \* Tool trolley
- \* Powder coated body for scratch and chemical resistance
- \* Internal locking system for extra security
- \* Wheels for mobility, convenience and durability



ITEM NO	SIZE(mm)	PCS	BARCODE
520601	735x380x654	1	6959820802179

**7 Drawers Roller Cabinet With Brake**

★ INTRODUCTION

- \* Strengthened Corner Protectors
- \* Auto Drawer Blocking System (one drawer at a time)
- \* Drawer Inner Liners



ITEM NO	SIZE(mm)	PCS	BARCODE
520605	675x450x810	1	6959820802186

**20Pcs 3/8" Socket Tools set**

★ INTRODUCTION

- \*11pcs 3/8" Socket: 8, 9, 10, 11, 12, 13, 14, 15, 16, 17, 19MM
- \*6pcs 3/8" Long socket: 10, 11, 12, 13, 14, 15MM
- \*1pc 3/8" Universal joint
- \*1pc 3/8" Extension bar: 150mm
- \*1pc 3/8" bent shank ratchet wrench



ITEM NO	SIZE	PCS	BARCODE
520632	3/8"	1	6959820852440

**51Pcs Socket Bits Set**

★ INTRODUCTION

- \*20pcs 1/4" Socket bits: Torx: T10,T15,T20,T25,T30,T40  
Hex: H3,H4,H5,H6,H7,H8Pozi: PZ1,PZ2,PZ3 Philips: PH1,PH2,PH3 Slotted: 5,5,7
- \*8pcs 1/2" Long socket: 10, 13, 14, 16, 17, 19, 21, 24MM
- \*22pcs 25mm Bits: Hex: H3,H4,H5,H6 Slotted: 3,4,5,6,7mm Philips: PH1,PH2,PH3 Pozi: PZ1,PZ2,PZ3 Torx:T10,T15,T20,T25,T27,T30,T40
- \*1pc 1/4" Adaptor bit to socket



ITEM NO	SIZE	PCS	BARCODE
520634	1/4" - 1/2"	1	6959820852464

**6pcs Screwdriver Set**

★ INTRODUCTION

- \*6pcs Screwdriver: PH2x38, PH0x75, PH1x100, PH2x150, SL5x100, SL6x150



ITEM NO	SIZE	PCS	BARCODE
520641	6pcs	1	6959820852495

**24Pcs 1/4" Socket Tools set**

★ INTRODUCTION

- \*13pcs 1/4" Socket: 4, 4.5, 5, 5.5, 6, 7, 8, 9, 10, 11, 12, 13, 14MM
- \*4pcs 1/4" Long socket: 8, 10, 12, 13MM
- \*1pc 1/4" Universal joint
- \*2pcs 1/4" Extension bar: 50mm, 100mm
- \*1pc 1/4" Spinner handle
- \*1pc 1/4" Sliding bar 110mm
- \*1pc 1/4" Spring bit adaptor 150mm
- \*1pc 1/4" bent shank ratchet wrench



ITEM NO	SIZE	PCS	BARCODE
520631	1/4"	1	6959820852433

**23Pcs 1/2" Socket Tools set**

★ INTRODUCTION

- \*18pcs 1/2" Socket: 10, 11, 12, 13, 14, 15, 16, 17, 18, 19, 20, 21, 22, 23, 24, 27, 30, 32MM
- \*1pc 1/2" Universal joint
- \*2pcs 1/2" Extension bar: 125mm, 250mm
- \*1pc 1/2" Sliding bar: 250mm
- \*1pc 1/2" bent shank ratchet wrench



ITEM NO	SIZE	PCS	BARCODE
520633	1/2"	1	6959820852457

**9Pcs Auto Repair Set**

★ INTRODUCTION

- \*1pc 3/8" Spark Plug: 14mm (Japanese Car)
- \*1pc Oil pan screw tool: VW#670902
- \*1pc Oil pan screw tool: AUD#670906
- \*2pc 1/2" Spark plug socket: 16, 21mm
- \*1pc Cylinder head screws: VW#670912
- \*1pc Automobile test pencil: #670121
- \*1pc Shock absorber screws: VW#670907
- \*1pc Filter wrench: #670911



ITEM NO	SIZE	PCS	BARCODE
520635	3/8" - 1/2"	1	6959820852471

**4Pcs Pliers Set**

★ INTRODUCTION

- \*4pcs Pliers: 8" Combination Plier #560228
- 6" Long Nose Plier #560201
- 6" Bent Nose Plier #560231
- 6" Diagonal Cutting Plier#560211



ITEM NO	SIZE	PCS	BARCODE
520642	4pcs	1	6959820852501



**2Pcs Hammers Set**

★ **INTRODUCTION**

- \* Machinist Hammer #590033
- \* Mallet with fiberglass handle 35mm

CS-45 S PRO



ITEM NO	SIZE	PCS	BARCODE
520643	35mm/300g	1	6959820852518

**4pcs Circlip Plier Set**

★ **INTRODUCTION**

- \*4pcs Circlip Plier Set
- 7" circlip pliers external straight jaw #560504 #560514
- 7" circlip pliers external bent jaw #560509 #560519

CS-55 PCF PRO



ITEM NO	SIZE	PCS	BARCODE
520645	7"	1	6959820852525

**201Pcs Hand Riveter Set**

★ **INTRODUCTION**

- \* 1pc 10" hand riveter #610102
- \* 50pcs aluminum rivet #610122: 2.4x8
- \* 50pcs aluminum rivet #610123: 3.2x10
- \* 50pcs aluminum rivet #610128: 4.0x12.7
- \* 50pcs aluminum rivet #610133 4.8x16

CS-45 OFU PRO



ITEM NO	SIZE	PCS	BARCODE
520646	10"	1	6959820852532

**21Pcs Plier Key Knife Set**

★ **INTRODUCTION**

- \*1pc Slip joint plier 10" #560421
- \*9pcs Hex key set #540605
- \*1pc Knife #570307
- \*10pcs Knife blade # 570343

CS-55 OFU PRO



ITEM NO	SIZE	PCS	BARCODE
520647	10" - 18x100mm	1	6959820852549

**35Pcs Plier Wrench Tape Set**

★ **INTRODUCTION**

- \*1pc Lock grip plier 10" #560628
- \*1pc Adjustable wrench 10" #540560
- \*1pc Measure tape #580035
- \*32pcs Feller gauge #580432

CS-45 HT PRO



ITEM NO	SIZE	PCS	BARCODE
520648	10"	1	6959820852556

**8Pcs File Repair Set**

★ **INTRODUCTION**

- \*1pc Flat file 8" #610637
- \*1pc Half round file 8" #610657
- \*1pc Air Blow Gun #671003
- \*5pcs coarse thread screw extractor set #610555

CS-45 H U PRO



ITEM NO	SIZE	PCS	BARCODE
520649	8"	1	6959820852563

**10Pcs Double Ring Spanner Set**

★ **INTRODUCTION**

- \*10pcs Double ring spanner:
- 6x7, 8x9, 10x11, 12x13, 14x15, 16x17, 18x19, 20x22, 21x23, 24x27mm

CR-V HT PRO



ITEM NO	SIZE	PCS	BARCODE
520640	10pcs	1	6959820852488

**8pcs T Handle Hex Key Set**

★ **INTRODUCTION**

- \*T handle hex key:
- #540701 2x75mm
- #540702 2.5x75mm
- #540703 3x75mm
- #540704 4x100mm
- #540705 5x150mm
- #540706 6x150mm
- #540707 8x200mm
- #540708 10x200mm

CR-V HT PRO

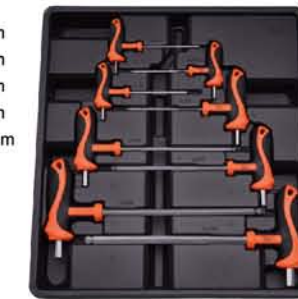

ITEM NO	SIZE	PCS	BARCODE
520656	8pcs	1	6959820852587

**8pcs T Handle Socket Wrench Set**

★ **INTRODUCTION**

- \*T Handle Socket Wrench
- #670201 6mm #670202 7mm #670203 8mm
- #670205 9mm #670206 10mm #670207 12mm
- #670208 13mm #670209 14mm

CR-V HT PRO



ITEM NO	SIZE	PCS	BARCODE
520658	8pcs	1	6959820852600

**18Pcs Combination Spanner Set**

★ **INTRODUCTION**

- \*Combination spanner:
- 6, 7, 8, 9, 10, 11, 12, 13, 14, 15, 16, 17, 18, 19, 20, 21, 22, 24mm

CR-V HT PRO



ITEM NO	SIZE	PCS	BARCODE
520655	18pcs	1	6959820852570

**8pcs T Handle Torx Key Set**

★ **INTRODUCTION**

- \*T Handle Torx Key:
- #540721 T10 3x75mm #540722 T15 3.5x75mm #540723 T20 4x100mm
- #540724 T25 4.5x100mm #540725 T27 5x150mm #540726 T30 5.5x150mm
- #540727 T40 7x150mm #540728 T45 8x200mm

CR-V HT PRO



ITEM NO	SIZE	PCS	BARCODE
520657	8pcs	1	6959820852594

**5Pcs Spanner Filter Set**

★ **INTRODUCTION**

- \*3pcs Combination spanner 32, 30, 27MM
- \*1pc Scraper 50MM
- \*1pc Oil filter wrench

CR-V HT PRO



ITEM NO	SIZE	PCS	BARCODE
520659	5pcs	1	6959820852617



## 1/4" Pro Quick Release Ratchet Wrench

### ★ INTRODUCTION

- \* Drop forged by tempered and hardened Chrome vanadium steel
- \* Easy and quick release reversing button
- \* 72T and rubber handle of Ergonomic design



ITEM NO	SIZE mm	L mm	OA mm	B mm	C mm	PCS	BARCODE
535303	1/4"	155	28.5	23	11.6	80	6959820845657

## 1/4" Hexagon Socket

### ★ INTRODUCTION

- \* Drop forged fine CRV and santi Chrome Finish

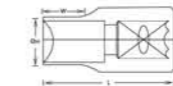

ITEM NO	SIZE mm	L mm	W mm	OH mm	OQ mm	PCS	BARCODE
530312	4	24.9	10.5	6.8	11.6	50	6959820803039
530313	4.5	24.9	10.5	7.3	11.7	50	6959820803046
530314	5	24.9	10.5	7.9	11.7	50	6959820803053
530315	5.5	24.9	10.5	8.6	11.7	50	6959820803060
530316	6	24.9	10.5	9.2	11.7	50	6959820803077
530317	7	24.9	10.5	10.6	11.7	50	6959820803084
530318	8	24.9	10.5	10.9	11.7	50	6959820803091
530319	9	24.9	10.5	11.4	12.7	50	6959820803107
530320	10	24.9	10.5	12.5	13.7	50	6959820803114
530321	11	24.9	10.5	13.4	15.5	50	6959820803121
530322	12	24.9	10.5	14.5	16.5	50	6959820803138
530323	13	24.9	10.5	15.5	17.6	50	6959820803145
530324	14	24.9	10.5	17.2	19.6	50	6959820803152

## 1/4" Spinner Handle Fixed Type

### ★ INTRODUCTION

- \* Drop forged fine CRV and santi Chrome Finish
- \* For 6.3mm sockets



ITEM NO	SIZE mm	L mm	A mm	PCS	BARCODE
530354	150	150	62	50	6959820803299

## 1/4" Spring Bit Adaptor

### ★ INTRODUCTION

- \* Drop forged fine CRV and santi Chrome Finish
- \* Best application for confined space



ITEM NO	SIZE mm	L mm	OA mm	B mm	PCS	BARCODE
530357	1/4"	150	11.7	6.3	50	6959820803329

## 1/4" Pro Quick Release Ratchet Wrench

### ★ INTRODUCTION

- \* Drop forged by tempered and hardened Chrome vanadium steel
- \* Easy and quick release reversing button
- \* 72T and rubber handle of Ergonomic design



ITEM NO	SIZE mm	L mm	OA mm	B mm	C mm	PCS	BARCODE
535304	1/4"	155	28.5	23	11.6	80	6959820845664

## 1/4" Extension Bar

### ★ INTRODUCTION

- \* Drop forged fine CRV and santi Chrome Finish

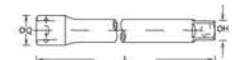

ITEM NO	SIZE mm	L mm	OH mm	OQ mm	PCS	BARCODE
530351	1/4"	50	6.3	12	50	6959820803268
530352	1/4"	100	6.3	12	50	6959820803275

## 1/4" T Handle Sliding Bar

### ★ INTRODUCTION

- \* Drop forged fine CRV and santi Chrome Finish

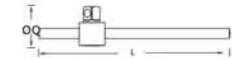

ITEM NO	SIZE mm	L mm	OQ mm	PCS	BARCODE
530353	1/4"	100	23.5	50	6959820803282

## 1/4" Universal Joint

### ★ INTRODUCTION

- \* Drop forged fine CRV and santi Chrome Finish



ITEM NO	SIZE mm	L mm	OQ mm	PCS	BARCODE
530355	1/4"	37	13.5	50	6959820803305

3/8" Pro Quick Release Ratchet Wrench

★ INTRODUCTION



- \* Drop forged by tempered and hardened Chrome vanadium steel
- \* Easy and quick release reversing button
- \* 72T and rubber handle of Ergonomic design

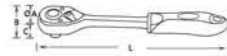

ITEM NO	SIZE	L	OA	B	C	PCS	BARCODE
	mm	mm	mm	mm	mm		
535403	3/8"	210	28.5	23	11.6	40	6959820845671

3/8" Hexagon Socket

★ INTRODUCTION



- \* Drop forged fine CRV and santi Chrome Finish

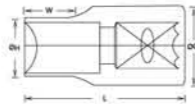

NO	ITEM NO	SIZE	L	W	OH	OQ	PCS	BARCODE
		mm	mm	mm	mm	mm		
530412	53412	6	28	10.0	10.4	16.8	50	6959820803350
530413	53413	7	28	11.5	11.0	16.8	50	6959820803367
530414	53414	8	28	11.5	12.7	16.8	50	6959820803374
530415	53415	9	28	11.5	13.5	16.8	50	6959820803381
530416	53416	10	28	11.5	14.5	16.8	50	6959820803398
530417	53417	11	28	11.5	15.8	16.8	50	6959820803404
530418	53418	12	28	11.5	15.8	16.8	50	6959820803411
530419	53419	13	28	11.5	16.5	17.8	50	6959820803428
530420	53420	14	28	11.5	18.0	19.8	50	6959820803435
530421	53421	15	28	11.5	18.0	21.8	50	6959820803442
530422	53422	16	28	11.5	18.0	21.8	50	6959820803459
530423	53423	17	30	12.6	20.0	23.7	50	6959820803466
530424	53424	18	30	12.6	21.0	25.7	50	6959820803473
530425	53425	19	30	12.6	21.0	25.7	50	6959820803480
530426	53426	20	30	12.6	23.0	27.7	50	6959820803497
530427	53427	21	30	12.6	23.0	28.0	50	6959820803503
530428	53428	22	30	12.6	25.0	29.8	50	6959820803510
530429	53429	24	30	12.6	25.0	31.7	50	6959820803527

3/8" Pro Quick Release Ratchet Wrench

★ INTRODUCTION



- \* Drop forged by tempered and hardened Chrome vanadium steel
- \* Easy and quick release reversing button
- \* 72T and rubber handle of Ergonomic design



ITEM NO	SIZE	L	OA	B	C	PCS	BARCODE
	mm	mm	mm	mm	mm		
535404	3/8"	210	28.5	23	11.6	40	6959820845688

1/4" Extention Bar

★ INTRODUCTION



- \* Drop forged fine CRV and santi Chrome Finish

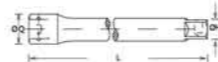

ITEM NO	SIZE	L	OH	OQ	PCS	BARCODE
	mm	mm	mm	mm		
530451	3/8"	75	10	18	50	6959820803688
530452	3/8"	150	10	18	25	6959820803695

3/8" T Handle Sliding Bar

★ INTRODUCTION



- \* Drop forged fine CRV and santi Chrome Finish



ITEM NO	SIZE	L	W	PCS	BARCODE
	mm	mm	mm		
530453	3/8"	150	32.4	25	6959820803701

3/8" Universal Joint

★ INTRODUCTION



- \* Drop forged fine CRV and santi Chrome Finish

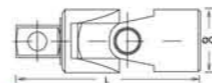

ITEM NO	SIZE	L	OQ	PCS	BARCODE
	mm	mm	mm		
530454	3/8"	54	18.8	50	6959820803718

1/2" Pro Quick Release Ratchet Wrench

★ INTRODUCTION



- \* Drop forged by tempered and hardened Chrome vanadium steel
- \* Easy and quick release reversing button
- \* 72T and rubber handle of Ergonomic design

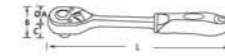

ITEM NO	SIZE	L	OA	B	C	PCS	BARCODE
	mm	mm	mm	mm	mm		
535503	1/2"	255	28.5	23	11.6	30	6959820845695

1/2" Hexagon Socket

★ INTRODUCTION



- \* Drop forged fine CRV and santi Chrome Finish

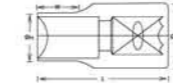

ITEM NO	SIZE	L	W	OH	OQ	PCS	BARCODE
	mm	mm	mm	mm	mm		
535508	8	38	14	13.7	21.8	50	6959820845947
535509	9	38	14	14.0	21.8	50	6959820845954
535510	10	38	14	15.3	21.8	50	6959820845961
535511	11	38	14	16.8	21.8	50	6959820845978
535512	12	38	14	17.0	21.8	50	6959820845985
535513	13	38	14	19.0	21.8	50	6959820845992
535514	14	38	14	20.3	21.8	50	6959820846005
535515	15	38	14	19.0	21.8	50	6959820846012
535516	16	38	14	21.8	20.8	50	6959820846029
535517	17	38	14	23.7	21.5	50	6959820846036
535518	18	38	14	25.5	22.5	50	6959820846043
535519	19	38	14	25.7	22.9	50	6959820846050
535520	20	38	17	27.8	24.0	50	6959820846067
535521	21	38	17	27.8	24.0	50	6959820846074
535522	22	38	17	29.7	25.9	50	6959820846081
535523	23	38	17	31.7	26.0	50	6959820846098
535524	24	38	17	31.7	26.0	50	6959820846104
535527	27	42	21	35.8	30.0	50	6959820846111
535530	30	42	21	39.7	32.0	20	6959820846128
535532	32	42	21	41.8	34.0	20	6959820846135

1/2" L Type Wrench

★ INTRODUCTION



- \* Drop forged fine CRV and mirror Chrome Finish

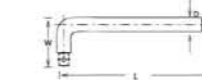

ITEM NO	SIZE	L	W	OD	PCS	BARCODE
	mm	mm	mm	mm		
530556	250	315	50	16	25	6959820804180

1/2" Pro Quick Release Ratchet Wrench

★ INTRODUCTION



- \* Drop forged by tempered and hardened Chrome vanadium steel
- \* Easy and quick release reversing button
- \* 72T and rubber handle of Ergonomic design

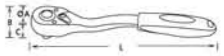

ITEM NO	SIZE	L	OA	B	C	PCS	BARCODE
	mm	mm	mm	mm	mm		
535504	1/2"	255	28.5	23	11.6	30	6959820845701

1/2" Extention Bar

★ INTRODUCTION



- \* Drop forged fine CRV and santi Chrome Finish

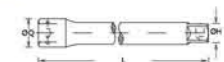

ITEM NO	SIZE	L	OH	OQ	PCS	BARCODE
	mm	mm	mm	mm		
530551	1/2"	125	12.5	22.4	50	6959820804142
530552	1/2"	250	12.5	22.4	25	6959820804159

1/2" T Handle Sliding Bar

★ INTRODUCTION



- \* Drop forged fine CRV and mirror Chrome Finish

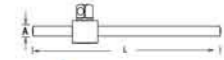

ITEM NO	SIZE	L	A	PCS	BARCODE
	mm	mm	mm		
530553	1/2"	250	13.5	25	6959820804166

1/2" Universal Joint

★ INTRODUCTION



- \* Drop forged fine CRV and mirror Chrome Finish

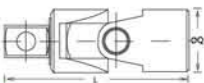

ITEM NO	SIZE	L	OQ	PCS	BARCODE
	mm	mm	mm		
530554	1/2"	72	25	50	6959820804173

3/4" Quick Release Ratchet Wrench

★ INTRODUCTION

\* Drop forged fine CRV and mirror Chrome Finish

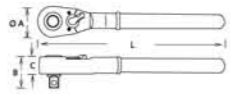

ITEM NO	SIZE mm	L mm	OA mm	B mm	C mm	PCS	BARCODE
535601	3/4"	490	63.5	58	31	6	6959820804203

3/4" Bi-hexagon Socket

★ INTRODUCTION

\* Drop forged fine CRV and mirror Chrome Finish

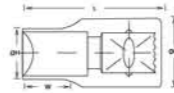

ITEM NO	SIZE mm	L mm	W mm	OH mm	OQ mm	PCS	BARCODE
530611	19	50.0	18.0	30.0	35.8	50	6959820804210
530612	21	50.0	18.0	32.0	35.8	50	6959820804227
530613	22	50.0	18.0	33.0	35.8	50	6959820804234
530614	23	50.0	18.0	33.0	35.8	50	6959820804241
530615	24	50.0	18.0	34.0	35.8	50	6959820804258
530616	25	51.0	18.0	35.8	35.8	50	6959820804265
530617	26	51.0	18.0	35.8	35.8	50	6959820804272
530618	27	52.0	27.5	37.8	34.0	50	6959820804289
530619	28	52.0	26.0	39.8	34.4	50	6959820804296
530620	29	52.0	24.0	39.8	34.8	50	6959820804302
530621	30	53.0	26.8	41.8	36.0	50	6959820804319
530622	32	54.0	28.4	43.7	37.0	50	6959820804326
530623	33	56.0	30.4	45.6	38.0	50	6959820804333
530624	34	56.0	30.0	47.0	38.2	20	6959820804340
530625	35	58.0	32.5	47.7	42.0	20	6959820804357
530626	36	58.0	32.6	49.5	42.2	20	6959820804364
530627	38	60.0	33.2	51.6	45.0	20	6959820804371
530628	41	64.0	34.0	56.0	45.0	20	6959820804388
530629	46	68.0	37.2	61.8	48.5	20	6959820804395
530630	50	72.0	41.3	68.0	48.0	20	6959820804401
530631	55	76.0	42.8	74.0	48.0	20	6959820804418
530632	60	77.8	42.5	80.0	48.0	20	6959820804425

3/4" Extension Bar

★ INTRODUCTION

\* Dropped forged fine CRV and mirror Chrome Finish



ITEM NO	SIZE mm	L mm	OH mm	OQ mm	PCS	BARCODE
530651	100	100	19	35.6	30	6959820804432
530652	200	200	19	35.6	20	6959820804449

3/4" T Handle Sliding Bar

★ INTRODUCTION

\* Dropped forged fine CRV and mirror Chrome Finish

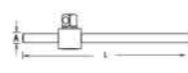

ITEM NO	SIZE mm	L mm	A mm	PCS	BARCODE
530653	450	450	20	10	6959820804456

3/4" Universal Joint

★ INTRODUCTION

\* Dropped forged fine CRV and mirror Chrome Finish

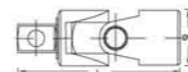

ITEM NO	SIZE mm	L mm	OQ mm	PCS	BARCODE
530654	3/4"	110	39.7	25	6959820804463

3/4" L Type Wrench

★ INTRODUCTION

\* Drop forged fine CRV and mirror Chrome Finish



ITEM NO	SIZE mm	L mm	W mm	D mm	PCS	BARCODE
530655	3/4"	390	97	24.8	10	6959820804470

1/4" (5-25N.m) Torque Wrench

★ INTRODUCTION

- \* ±3% tolerance
- \* 72Teeth Cr-Mo ratchet drive head
- \* Aluminum handle
- \* 1PC 1/4"(5-25N.m) Torque Wrench
- \* 1PC 1/4" Extension Bar
- \* 6pcs 2.5,3,4,5,6,8mm
- \* 3pcs T25,T27,T30
- \* 2pcs PH1,PH2

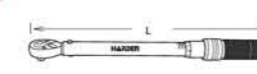

ITEM NO	SIZE(mm)	N.m	L(mm)	PCS	BARCODE
538014	1/4"	5-25N.m	245	8	6959820850774

1/2" Torque Wrench

★ INTRODUCTION

- \* ±3% tolerance
- \* 72Teeth Cr-Mo ratchet drive head
- \* Aluminum handle

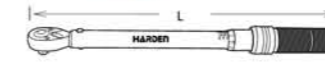

ITEM NO	SIZE(mm)	N.m	L(mm)	PCS	BARCODE
538111	1/2"	10-110N.m	475	16	6959820850798
538121	1/2"	30-210N.m	500	16	6959820850804
538131	1/2"	60-330N.m	560	12	6959820850811

OPERATION

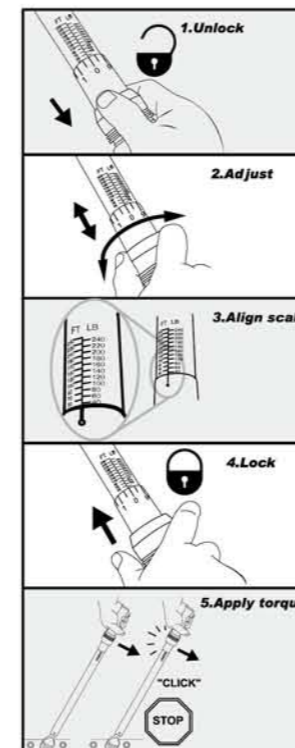

STANDARD

■ We calibrate each torque wrench at the factory using torque standards according to DIN ISO 6789 & ASME B107.14M-1994, and certifies it meets the accuracy requirements of specifications DIN ISO 6789 & ASME B107.14M-1994

CONVERT FROM	TO	MULTIPLY BY
oz-in	in-lb	0.0625
in-lb	in-oz	16
in-lb	kg-cm	1.1519
in-lb	ft-lb	0.083333
in-lb	kg-m	0.011519
in-lb	N-m	0.1130
in-lb	dN-m	1.130
ft-lb	Nm	1.356
ft-lb	kg-m	0.1382
ft-lb	in-lb	12
N-m	dN-m	10
N-m	kg-cm	10.20
N-m	kg-m	0.10197
N-m	in-lb	8.8507
N-m	ft-lb	0.73756
dN-m	in-lb	0.885
dN-m	N-m	0.100
kg-cm	in-lb	0.8681
kg-cm	N-m	0.09807
kg-m	ft-lb	7.236
kg-m	N-m	9.807

3/8" (10-110N.m) Torque Wrench

★ INTRODUCTION

- \* ±3% tolerance
- \* 72Teeth Cr-Mo ratchet drive head
- \* Aluminum handle

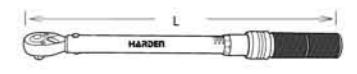

ITEM NO	SIZE(mm)	N.m	L(mm)	PCS	BARCODE
538083	3/8"	10-110N.m	470	16	6959820850781

3/4" Torque Wrench

★ INTRODUCTION

- \* ±3% tolerance
- \* 24Teeth Cr-Mo ratchet drive head
- \* Nylon handle

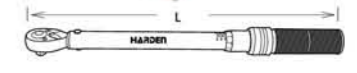

ITEM NO	SIZE(mm)	N.m	L(mm)	PCS	BARCODE
538255	3/4"	100-550N.m	820	4	6959820854413

CARE AND MAINTENANCE

- After using the torque wrench please remember to adjust the torque scale to the zero and store in the box.
- The torque wrench is lubricated and should not be oiled. The only except is the ratchet head may be needed for Smooth operation.
- The torque wrench is a precision measuring instrument. Calibration must be done regularly to ensure accuracy. Suggested calibration period is at least every year or even shorter depending on situation.
- Never disassemble the torque wrench by yourself. For any need to disassemble the torque wrench or repair it, please look for assistance from qualified service station.



- WARNING**  
INJURY MAY RESULT FROM
- ELECTRICAL SHOCK**  
HANDLE IS NOT INSULATED. DO NOT USE ON LIVE ELECTRICAL OR HIGH VOLTAGE CIRCUITS.

SAFETY INSTRUCTIONS

- WARNING**  
RISK OF FLYING PARTICLES
- DO NOT USE TORQUE WRENCH AS A HAMMER.
- NEVER USE TORQUE WRENCH TO BREAK LOOSE FASTENERS.
- USE OF DAMAGED HAND TOOLS, SOCKETS, EXTENSIONS AND ACCESSORIES MAY RESULT IN INJURY.
- TORQUE WRENCHES NOT IN CALIBRATION MAY CAUSE DAMAGE TO PARTS OR TOOLS.
- DO NOT USE EXTENSIONS ON HANDLE AS DAMAGE TO TORQUE WRENCH WILL RESULT.
- OVER TIGHTENING OF FASTENERS MAY RESULT IN BREAKAGE.

**ALWAYS USE EYE PROTECTION WHILE USING HAND TOOLS**

# SPANNER TOOLS



## 14Pcs Combination Spanner

### ★ INTRODUCTION

CR-V HT PRO

\* Manufactured from chrome vanadium steel

with matte chrome plated finish

\* Size range: 8,9,10,11,12,13,14,15,16,17,18,19,22,24mm



ITEM NO	PCS	BARCODE
540I01	10	6959820808003

## 8Pcs Combination Spanner

### ★ INTRODUCTION

CR-V HT PRO

\* Manufactured from chrome vanadium steel

with matte chrome plated finish

\* Size range: 8,10,12,13,14,15,17,19mm



ITEM NO	PCS	BARCODE
540I04	20	6959820847002

## 10Pcs Combination Spanner

### ★ INTRODUCTION

CR-V HT PRO

\* Manufactured from chrome vanadium steel

with matte chrome plated finish

\* Size range: 8,9,10,11,12,14,15,17,19,22mm



ITEM NO	PCS	BARCODE
540I05	20	6959820847019

## 12Pcs Ring Spanner

### ★ INTRODUCTION

CR-V HT PRO

\* Manufactured from chrome vanadium steel

with matte chrome plated finish

\* Size range: 6x7,8x9,10x11,12x13,14x15,16x17,18x19,20x22,21x23,24x27,25x28,30x32mm



ITEM NO	PCS	BARCODE
540I10	6	6959820850156

## 12Pcs Double Open-end Spanner

### ★ INTRODUCTION

CR-V HT PRO

\* Manufactured from chrome vanadium steel

with matte chrome plated finish

\* Size range: 6x7,8x9,10x11,12x13,14x15,16x17,18x19,20x22,21x23,24x27,25x28,30x32mm



ITEM NO	PCS	BARCODE
540I08	10	6959820847040

## 23Pcs Combination Spanner

### ★ INTRODUCTION

CR-V HT PRO

\* Manufactured from chrome vanadium steel

with matte chrome plated finish

\* Size range: 6,7,8,9,10,11,12,13,14,15,16,17,18,19,20,21,22,23,24,25,27,30,32mm



ITEM NO	PCS	BARCODE
540I06	5	6959820847026

7pcs Fixed combination gear spanner set

★ INTRODUCTION

- \* Include 8,10,12,13,14,17,19mm size
- \* Forged from Chrome Vanadium steel,hardened, tempered
- \* Santi matee, chrome plated for corrosion protection
- \* 72 Tooth ratchet head



72T TOOTH RATCHETHEAD

CR-V HEAT TREATED FULLY POLISHED



Combination Spanner

★ INTRODUCTION

- \* Forged from chrome vanadium steel,hardened, tempered
- \* Chrome plated for corrosion protection
- \* Broached jaws and rings to ensure a consistent tolerance and a guaranteed accurate



FORGED HIGH QUALITY STEEL



HEAT TREATED FULLY POLISHED

ITEM NO	SIZE mm	W mm	W1 mm	W2 mm	H mm	HI mm	L mm	PCS	BARCODE
541106	6	7.6	11.6	14.9	3.0	5.6	101	100	6959820849198
541107	7	8.2	12.8	16.9	3.2	5.9	101	100	6959820849204
541108	8	8.8	14.2	17.9	3.4	6.2	121	100	6959820849211
541109	9	9.4	15.5	19.4	3.6	6.5	131	100	6959820849228
541110	10	10.2	16.8	21.4	3.8	6.8	141	100	6959820849235
541111	11	10.8	18.0	23.4	4.4	7.1	152	80	6959820849242
541112	12	11.4	19.2	25.4	4.4	7.7	161	80	6959820849259
541113	13	12.0	20.5	27.4	4.6	8.1	172	60	6959820849266
541114	14	12.6	22.2	29.9	4.8	8.5	183	60	6959820849273
541115	15	13.2	23.5	31.9	5.0	8.9	191	60	6959820849280
541116	16	13.8	25.0	33.4	5.2	9.3	201	60	6959820849297
541117	17	14.2	26.5	35.4	5.4	9.7	211	60	6959820849303
541118	18	14.8	27.8	37.4	5.6	10.0	231	60	6959820849310
541119	19	15.4	29.5	39.4	5.8	10.3	242	60	6959820849327
541120	20	16.0	30.6	41.4	6.0	10.7	253	60	6959820849334
541121	21	16.6	32.0	43.4	6.2	11.0	262	60	6959820849341
541122	22	17.2	33.4	45.4	6.4	11.4	272	40	6959820849358
541123	23	17.8	34.5	46.9	6.6	11.9	283	40	6959820849365
541124	24	18.4	36.5	48.9	6.8	12.3	292	40	6959820849372
541125	25	19.0	37.8	50.9	7.0	13.0	301	40	6959820849389
541127	27	20.4	39.3	54.5	7.6	14.0	320	20	6959820849396
541130	30	22.0	43.6	60.5	8.2	14.7	336	20	6959820849402
541132	32	23.6	46.6	63.5	8.6	15.5	362	20	6959820849419
541133	33	29.0	47.0	67.0	10.0	19.0	426	20	6959820853447
541136	36	30.5	53.0	72.0	10.2	19.0	435	16	6959820811317
541141	41	34.0	62.0	82.5	11.5	21.0	465	10	6959820811324
541146	46	36.0	68.0	94.0	12.0	21.5	490	10	6959820811331
541150	50	36.0	74.3	102.0	12.2	22.0	503	10	6959820811348

ITEM NO	SIZE	H mm	W1 mm	W2 mm	HI mm	L mm	PCS	BARCODE
540117	8MM	9.4	20.0	17.0	7.7	142	20	6959820849198
	10MM	11.0	23.5	22.0	7.9	163		
	12MM	12.0	27.0	26.0	9.1	173		
	13MM	13.5	28.5	27.8	9.6	187		
	14MM	13.5	30.5	30.0	9.6	198		
	17MM	16.2	35.0	39.0	11.0	230		
	19MM	17.2	36.5	42.0	11.5	252		

Double Open-end Spanner

★ INTRODUCTION

- \* Forged from chrome vanadium steel,hardened, tempered
- \* Chrome plated for corrosion protection
- \* Broached jaws and rings to ensure a consistent tolerance and a guaranteed accurate



FORGED HIGH QUALITY STEEL DOUBLE OPEN-END SPANNER

MATT POLISHED GOOD-LOOKING AND DURABLE



ITEM NO	SIZE mm	W mm	W1 mm	W2 mm	H mm	HI mm	L mm	PCS	BARCODE
541206	6x7	9.8	18.9	16.0	3.2	4.6	108	100	6959820849549
541208	8x9	11.3	24.2	20.2	3.5	5.0	123	100	6959820849556
541210	10x11	11.7	27.2	23.1	3.7	5.3	137	80	6959820849563
541212	12x13	13.8	31.8	28.8	4.1	5.8	152	80	6959820849570
541214	14x15	15.5	34.3	31.7	4.5	6.2	167	60	6959820849587
541216	16x17	15.8	36.3	33.5	4.7	6.6	174	60	6959820849594
541218	18x19	18.1	44.3	40.5	5.3	7.4	208	60	6959820849600
541220	20x22	18.9	46.5	42.1	5.5	7.7	219	60	6959820849617
541221	21x23	19.7	48.1	44.3	5.7	8.0	230	40	6959820849624
541224	24x27	21.5	53.0	46.9	6.4	9.0	245	40	6959820849631
541225	25x28	23.5	54.9	49.5	6.8	10.0	257	20	6959820849648
541230	30x32	25.5	65.0	61.0	8.0	11.0	290	20	6959820849655

Double Socket Wrench

★ INTRODUCTION

- \* Forged from Chrome Vanadium steel, hardened, tempered
- \* Bright chrome plated for corrosion protection



ITEM NO	SIZE(mm)	L(mm)	H(mm)	W(mm)	PCS	BARCODE
540311	8x9	180	13	11	144	6959820811812
540312	10x11	205	14	11	126	6959820811829
540313	12x13	225	17	15	108	6959820811836
540315	14x15	248	20	16	84	6959820811843
540316	16x17	255	22	17	72	6959820811850
540317	18x19	276	30	19	72	6959820811867

Double Ring Spanner

★ INTRODUCTION

- \* Forged from chrome vanadium steel,hardened, tempered
- \* Chrome plated for corrosion protection
- \* Broached jaws and rings to ensure a consistent tolerance and a guaranteed accurate



DIFFERENT SIZES FOR EACH RING HIGH PERFORMANCE

HEAT TREATED HIGH HARDNESS STRONG AND DURABLE FOR LONG TIME USE



ITEM NO	SIZE mm	W mm	W1 mm	W2 mm	H mm	HI mm	L mm	PCS	BARCODE
541306	6x7	8.0	10.2	12.6	3.5	6.0	118	60	6959820849426
541308	8x9	9.5	13.6	16.5	3.9	6.4	138	60	6959820849433
541310	10x11	11.0	16.1	19.0	4.3	7.8	160	60	6959820849440
541313	12x13	12.0	19.2	21.5	4.7	8.5	185	40	6959820849457
541314	14x15	13.0	21.5	25.8	5.7	9.4	217	40	6959820849464
541316	16x17	13.0	24.5	27.2	6.0	10.0	220	40	6959820849471
541318	18x19	17.0	29.0	33.0	6.7	11.5	268	40	6959820849488
541320	20x22	17.0	29.0	33.0	6.7	11.5	268	20	6959820849495
541321	21x23	17.5	33.0	36.0	7.1	12.5	295	20	6959820849501
541324	24x27	18.0	37.0	41.0	8.0	13.5	341	20	6959820849518
541325	25x28	19.0	40.0	44.5	8.6	14.5	395	20	6959820849525
541330	30x32	20.0	44.5	47.5	9.4	15.0	400	20	6959820849532

Ratchet Combination Spanner

★ INTRODUCTION

- \* Forged from high quality Chrome Vanadium steel, hardened, tempered
- \* Bright chrome plated for corrosion protection



ITEM NO	SIZE	W mm	W1 mm	H mm	HI mm	L mm	PCS	BARCODE
540326	19x22-22	19	22	22	19	283	40	6959820832770
540329	21x22-22	20	22	22	21	285	40	6959820832787

**Flexible Ratchet Combination Wrench**

**★ INTRODUCTION**



- \* Forged from Chrome Vanadium steel, hardened, tempered
- \* Chrome plated for corrosion protection
- \* 72 Tooth ratchet head or easy access in confined spaces



ITEM NO	SIZE mm	W mm	W1 mm	W2 mm	H mm	HI mm	L mm	PCS	BARCODE
540201	8	8.2	19.2	17.6	3.5	7.5	138	240	6959820808034
540202	9	8.8	21.0	19.5	3.5	7.5	150	240	6959820808041
540203	10	9.8	22.2	21.2	3.5	7.8	158	240	6959820808058
540204	11	11.2	24.4	24.0	3.8	8.3	163	240	6959820808065
540205	12	12.2	26.0	25.8	3.8	8.8	166	144	6959820808072
540206	13	12.5	27.0	27.5	4.0	9.0	178	144	6959820808089
540207	14	13.6	29.0	29.5	4.2	9.2	189	144	6959820808096
540208	15	15.0	30.0	32.5	4.8	9.2	197	108	6959820808102
540209	16	15.0	32.0	34.0	5.0	10.2	209	108	6959820808119
540210	17	15.5	34.5	35.4	5.0	10.2	224	108	6959820808126
540211	18	16.8	36.0	38.2	5.2	10.5	235	96	6959820808133
540212	19	16.8	36.5	39.5	5.2	11.0	243	96	6959820808140
540213	20	16.8	37.0	40.0	6.0	11.2	247	96	6959820808157
540214	21	19.2	43.5	45.0	6.2	13.5	290	60	6959820808164
540215	22	19.2	44.0	45.0	6.5	13.5	292	60	6959820808171
540216	24	22.5	49.0	52.0	7.0	14.2	334	24	6959820808188
540217	25	22.5	49.0	52.0	7.0	14.5	335	24	6959820808195

**Adjustable Wrench**

**★ INTRODUCTION**



- \* Forged from carbon steel, hardened, tempered
- \* Bright chrome plated for corrosion protection

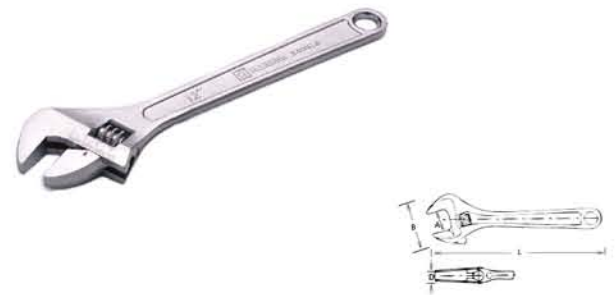

ITEM NO	SIZE mm	L mm	A mm	B mm	D mm	PCS	BARCODE
540506	6"	150	21.0	52.0	10.0	120	6959820808928
540508	8"	200	27.0	65.0	13.0	120	6959820808935
540510	10"	250	33.0	68.0	13.0	60	6959820808942
540512	12"	300	34.2	78.0	13.5	48	6959820808959
540515	15"	375	42.0	112	14.2	16	6959820808966
540518	18"	450	55.0	126	14.5	12	6959820832831
540524	24"	600	65.5	145	14.8	6	6959820808973

**L-type Wrench**

**★ INTRODUCTION**



- \* Forged from Crv
- \* Hardened and tempered
- \* Santi matee, chrome plated for corrosion protection



ITEM NO	SIZE(mm)	L(mm)	LI(mm)	H(mm)	PCS	BARCODE
541408	8mm	120	34	28	120	6959820852938
541409	9mm	130	34	29	120	6959820852945
541410	10mm	135	35	35	120	6959820852952
541411	11mm	150	36	36	120	6959820852969
541412	12mm	160	42	37	120	6959820852976
541413	13mm	165	42	42	120	6959820852983
541414	14mm	175	42	45	120	6959820852990
541415	15mm	200	50	45	80	6959820853003
541415	16mm	200	53	48	80	6959820853010
541417	17mm	200	58	50	80	6959820853027
541418	18mm	220	59	50	80	6959820853034
541419	19mm	220	60	52	80	6959820853041

**Pro Adjustable Wrench**

**★ INTRODUCTION**



- \* Quality carbon steel with Chrome plated
- \* Durable soft grip handle for comfortable Usage



ITEM NO	SIZE mm	L mm	A mm	B mm	D mm	PCS	BARCODE
540558	8"	200	32	70	13.5	48	6959820809048
540560	10"	250	38	75	14.0	48	6959820809055
540562	12"	300	45	87	14.5	24	6959820809062

**Multi-purpose Adjustable Wrench Set**

**★ INTRODUCTION**



- \* Forged from medium carbon steel
- \* Heat treated and tempered
- \* Durable soft grip handle for comfortable usage



ITEM NO	SIZE(mm)	PCS	BARCODE
540572	9-32mm	30	6959820809069

**9Pcs Medium Torx Key Wrench**

**★ INTRODUCTION**



- \* All keys are manufactured from fully hardened Chrome Vanadium steel
- \* Size range:T10,T15,T20,T25,T27,T30,T40,T45,T50



ITEM NO	PCS	BARCODE
540601	48	6959820810266

**9Pcs Medium Ball Key Wrench**

**★ INTRODUCTION**



- \* All keys are manufactured from fully hardened Chrome Vanadium steel
- \* Size range:1.5,2,2.5,3,4,5,6,8,10mm



ITEM NO	PCS	BARCODE
540603	48	6959820810280

**9Pcs Long Hex Key Wrench**

**★ INTRODUCTION**



- \* All keys are manufactured from fully hardened Chrome Vanadium steel
- \* Size range:1.5,2,2.5,3,4,5,6,8,10mm



ITEM NO	PCS	BARCODE
540605	48	6959820810303

**9Pcs Medium Hex Key Wrench**

**★ INTRODUCTION**



- \* All keys are manufactured from fully hardened Chrome Vanadium steel
- \* Size range:1.5,2,2.5,3,4,5,6,8,10mm



ITEM NO	PCS	BARCODE
540602	48	6959820810273

**9Pcs Long Torx Key Wrench**

**★ INTRODUCTION**



- \* All keys are manufactured from fully hardened Chrome Vanadium steel
- \* Size range:T10,T15,T20,T25,T27,T30,T40,T45,T50



ITEM NO	PCS	BARCODE
540604	48	6959820810297

**9Pcs Long Ball Key Wrench**

**★ INTRODUCTION**



- \* All keys are manufactured from fully hardened Chrome Vanadium steel
- \* Size range:1.5,2,2.5,3,4,5,6,8,10mm



ITEM NO	PCS	BARCODE
540606	48	6959820810310

**9Pcs Extra Long Torx Key Wrench**

★ **INTRODUCTION**

- \* All keys are manufactured from fully hardened Chrome Vanadium steel
- \* Size range:T10,T15,T20,T25,T27,T30,T40,T45,T50



ITEM NO	PCS	BARCODE
540607	48	6959820810327

**9Pcs Extra Long Hex Key Wrench**

★ **INTRODUCTION**

- \* All keys are manufactured from fully hardened Chrome Vanadium steel
- \* Size range:1.5,2,2.5,3,4,5,6,8,10mm

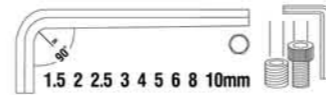

ITEM NO	PCS	BARCODE
540608	48	6959820810334

**9Pcs Extra Long Ball Key Wrench**

★ **INTRODUCTION**

- \* All keys are manufactured from fully hardened Chrome Vanadium steel
- \* Size range:1.5,2,2.5,3,4,5,6,8,10mm

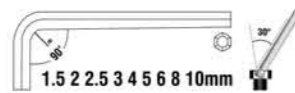

ITEM NO	PCS	BARCODE
540609	48	6959820810341

**13Pcs Inch Long Hex Key Wrench**

★ **INTRODUCTION**

- \*All keys are manufactured from fully hardened Chrome Vanadium steel
- \*Satin finish surface for corrosion resist
- \*Size:1/20", 1/16", 5/64", 3/32", 7/64", 1/8", 9/64", 5/32", 3/16", 7/32", 1/4", 5/16", 3/8"
- \*All keys are manufactured from fully hardened Chrome Vanadium steel
- \*Satin finish surface for corrosion resist
- \*Size:1/20", 1/16", 5/64", 3/32", 7/64", 1/8", 9/64", 5/32", 3/16", 7/32", 1/4", 5/16", 3/8"

**INCH**

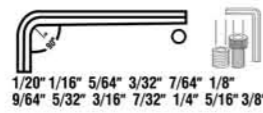

ITEM NO	PCS	BARCODE
540613	48	695982081658

**7 In 1 Hex Key Wrench**

★ **INTRODUCTION**

- \* Forged from high quality #6150 Chrome Vanadium steel
- \* Satin finish surface for corrosion resist



ITEM NO	PCS	BARCODE
540610	72	6959820810259

**Extra Long Ball Key Wrench**

★ **INTRODUCTION**

- \* Forged from high quality Chrome Vanadium Steel,hardened, tempered
- \* The ball type for easy access in confined spaces



ITEM NO	SIZE mm	L mm	H mm	PCS	BARCODE
540620	1.5*20pcs	91	16	150	6959820810358
540621	2.0*20pcs	102	18	150	6959820810365
540622	2.5*20pcs	114	20	100	6959820810372
540623	3.0*20pcs	120	22	100	6959820810389
540624	4.0*10pcs	142	30	100	6959820810396
540625	5.0*10pcs	156	36	48	6959820810402
540626	6.0*10pcs	188	38	32	6959820810419
540627	7.0*10pcs	197	40	20	6959820810426
540628	8.0*10pcs	209	44	20	6959820810433
540629	10.0*1pc	235	50	18	6959820810440
540630	12.0*1pc	200	54	96	6959820810457
540631	14.0*1pc	220	68	80	6959820810464
540633	17.0*1pc	250	65	48	6959820810471
540635	19.0*1pc	276	69	36	6959820810488

**Extra Long Hex Key Wrench**

★ **INTRODUCTION**

- \* Forged from high quality Chrome Vanadium steel,hardened, tempered
- \* Design for hard to reach places



ITEM NO	SIZEmm	L mm	H mm	PCS	BARCODE
540640	1.5*20pcs	91	16	150	6959820810495
540641	2.0*20pcs	102	18	150	6959820810501
540642	2.5*20pcs	114	20	100	6959820810518
540643	3.0*20pcs	120	22	100	6959820810525
540644	4.0*10pcs	142	30	100	6959820810532
540645	5.0*10pcs	156	36	48	6959820810549
540646	6.0*10pcs	188	38	32	6959820810556
540647	7.0*10pcs	197	40	20	6959820810563
540648	8.0*10pcs	209	44	20	6959820810570
540649	10.0*8pcs	235	50	18	6959820810587
540650	12.0*1pc	200	54	96	6959820810594
540651	14.0*1pc	220	68	96	6959820810600
540652	16.0*1pc	245	72	48	6959820810617
540653	17.0*1pc	250	78	48	6959820810624
540654	18.0*1pc	265	68	36	6959820810631
540655	19.0*1pc	276	70	36	6959820810648
540656	22.0*1pc	300	100	24	6959820810655
540657	24.0*1pc	370	88	10	6959820810662
540658	27.0*1pc	410	97.5	10	6959820810679
540659	30.0*1pc	460	110	6	6959820810686
540660	32.0*1pc	480	150	6	6959820810693
540661	36.0*1pc	520	175	4	6959820810709

**Long Torx Hex Key Wrench**

★ **INTRODUCTION**

- \* Forged from high quality Chrome Vanadium steel,hardened, tempered
- \* Design for hard to reach places

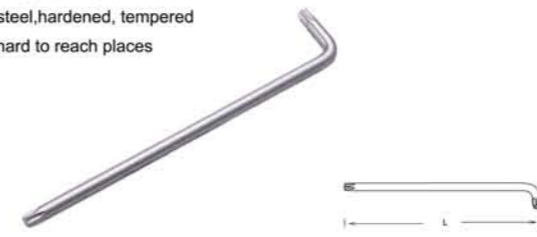

ITEM NO	SIZEmm	L mm	H mm	PCS	BARCODE
540665	T6*20pcs	55	16	90	6959820810716
540666	T7*20pcs	55	16	90	6959820810723
540667	T8*20pcs	55	16	90	6959820810730
540668	T9*20pcs	55	16	90	6959820810747
540669	T10*20pcs	90	14	90	6959820810754
540670	T15*20pcs	99	15	90	6959820810761
540671	T20*10pcs	112	20	120	6959820810778
540672	T25*10pcs	124	21	120	6959820810785
540673	T27*10pcs	141	23	80	6959820810792
540674	T30*10pcs	155	27	60	6959820810808
540675	T40*10pcs	175	32	32	6959820810815
540676	T45*10pcs	200	35	24	6959820810822
540677	T50*8pcs	223	41	18	6959820810839

**T-handle Hex Key Wrench With Ball**

★ **INTRODUCTION**

- \* Forged from high quality Chrome Vanadium steel,hardened, tempered
- \* Satin finish and Chrome plated for corrosion resist
- \* T handle gives extra torque power
- \* Ball end for angled applications



ITEM NO	SIZE mm	L mm	H mm	W mm	D mm	PCS	BARCODE
540701	2X75	116	80	75	20	500	6959820810846
540702	2.5X75	116	80	75	20	500	6959820810853
540703	3X75	116	80	75	20	500	6959820810860
540704	4X100	141	80	100	20	200	6959820810877
540705	5X150	191	80	150	20	200	6959820810884
540706	6X150	195	104	140	20	200	6959820810891
540707	8X200	255	104	204	21	100	6959820810907
540708	10X200	255	104	204	21	100	6959820810914

**T-handle Hex Key Wrench**

★ **INTRODUCTION**

- \* Forged from high quality Chrome Vanadium steel,hardened, tempered
- \* T handle gives extra torque power
- \* Satin finish and Chrome plated for corrosion resist



ITEM NO	SIZE mm	L mm	H mm	W mm	D mm	PCS	BARCODE
540711	2.0X75	116	80	75	20	500	6959820810921
540712	2.5X75	116	80	75	20	500	6959820810938
540713	3.0X75	116	80	75	20	500	6959820810945
540714	4.0X100	141	80	100	20	200	6959820810952
540715	5.0X150	191	80	150	20	200	6959820810969
540716	6.0X150	195	104	140	20	200	6959820810976
540717	8.0X200	255	104	204	21	100	6959820810983
540718	10.0X200	255	104	204	21	100	6959820810990

**T-handle Torx Hex Key Wrench**

★ **INTRODUCTION**

- \* Forged from high quality Chrome Vanadium steel,hardened, tempered
- \* T handle gives extra torque power
- \* Satin finish and Chrome plated for corrosion resist



ITEM NO	SIZE mm	L mm	H mm	W mm	D mm	PCS	BARCODE
540721	T10 3x75	116	80	75	20	500	6959820811003
540722	T15 3.5x75	122	80	75	20	500	6959820811010
540723	T20 4x100	141	80	100	20	500	6959820811027
540724	T25 4.5x100	141	80	100	20	200	6959820811034
540725	T27 5x150	191	80	150	20	200	6959820811041
540726	T30 5.5x150	202	104	150	21	200	6959820811058
540727	T40 7x150	202	104	154	21	200	6959820811065
540728	T45 8x200	255	104	204	21	100	6959820811072
540727	T50 9x200	255	104	204	21	100	6959820811089



## Flat Type Precision Screwdriver

### ★ INTRODUCTION

- \* The head is made of high class CRV
- \* The handle is made of ABS plastic and the cap can spin easily
- \* Easy operation

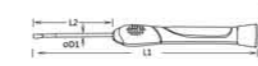

ITEM NO	SIZE mm	L1 mm	L2 mm	ØD1 mm	ØD2 mm	PCS	BARCODE
550101	1.4X50	131	50	3	14.5	120	6959820809079
550102	2.0X50	131	50	3	14.5	120	6959820809086
550103	3.0X50	131	50	3	14.5	120	6959820809093
550104	4.0X50	131	50	3	14.5	120	6959820809109

## Torx Type Precision Screwdriver

### ★ INTRODUCTION

- \* The head is made of high class CRV
- \* The handle is made of ABS plastic and the cap can spin easily
- \* Easy operation

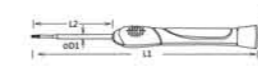

ITEM NO	SIZE mm	L1 mm	L2 mm	ØD1 mm	ØD2 mm	PCS	BARCODE
550109	T4X50	131	50	3	14.5	120	6959820809154
550110	T6X50	131	50	3	14.5	120	6959820809161
550111	T8X50	131	50	3	14.5	120	6959820809178
550112	T10X50	131	50	3	14.5	120	6959820809185

## Flat Type Screwdriver

### ★ INTRODUCTION

- \* Flat Type Screwdriver
- \* CRV Screwdriver with Transparent Handle
- \* Tempered and magnetic

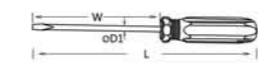

ITEM NO	SIZE mm	L mm	W mm	ØD1 mm	ØD2 mm	PCS	BARCODE
550203	3X100	160	100	3	15	144	6959820809314
550206	5X150	230	150	5	20	144	6959820809345
550209	6X150	240	150	6	23	144	6959820809376
550211	8X150	256	150	8	25	72	6959820809390
550212	8X200	306	200	8	25	72	6959820809406

## Philips Type Precision Screwdriver

### ★ INTRODUCTION

- \* The head is made of high class CRV
- \* The handle is made of ABS plastic and the cap can spin easily
- \* Easy operation

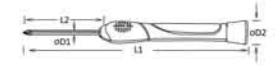

ITEM NO	SIZE mm	L1 mm	L2 mm	ØD1 mm	ØD2 mm	PCS	BARCODE
550105	PH00X50	131	50	3	14.5	120	6959820809116
550106	PH00X50	131	50	3	14.5	120	6959820809123
550107	PH0X50	131	50	3	14.5	120	6959820809130
550108	PH1X50	131	50	3	14.5	120	6959820809147

## Hexagon Type Precision Screwdriver

### ★ INTRODUCTION

- \* The head is made of high class CRV
- \* The handle is made of ABS plastic and the cap can spin easily
- \* Easy operation



ITEM NO	SIZE mm	L1 mm	L2 mm	ØD1 mm	ØD2 mm	PCS	BARCODE
550115	1.5X50	131	50	3	14.5	120	6959820809192
550116	2.0X50	131	50	3	14.5	120	6959820809208
550117	2.5X50	131	50	3	14.5	120	6959820809215

## Philips Type Screwdriver

### ★ INTRODUCTION

- \* Philips Type Screwdriver
- \* CRV Screwdriver with Transparent Handle
- \* Tempered and magnetic

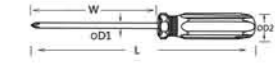

ITEM NO	SIZE mm	L mm	W mm	ØD1 mm	ØD2 mm	PCS	BARCODE
550222	PH1X38	81	38	5	26	144	6959820809420
550224	PH0X100	160	100	3	15	144	6959820809444
550227	PH1X150	230	150	5	20	144	6959820809475
550230	PH2X150	240	150	6	23	144	6959820809505
550233	PH3X200	306	200	8	25	72	6959820809536

Slotted Screwdriver

★ INTRODUCTION

- \* CRV and tempered
- \* Comfortable TPR handle
- \* Designed bottom for striking

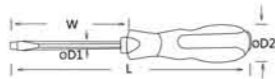

ITEM NO	SIZE mm	L mm	W mm	ØD1 mm	ØD2 mm	PCS	BARCODE
550306	5X100	207	100	5	30	144	6959820809574
550309	6X150	260	150	6	31	144	6959820809598
550312	8X200	320	300	8	35	144	6959820809611

Pro Screwdriver

★ INTRODUCTION

- \* CRV and tempered
- \* Comfortable TPR handle
- \* For high used frequency workplace

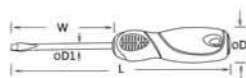

ITEM NO	SIZE mm	L mm	W mm	ØD1 mm	ØD2 mm	PCS	BARCODE
550352	3X75	145	75	3	20	240	6959820809697
550355	5X100	201	100	5	30	144	6959820809727
550357	6X38	99	38	6	33	144	6959820809741
550359	6X150	260	150	6	33	144	6959820809765
550361	8X200	320	200	8	37	72	6959820809789

Screwdriver with Soft Handle

★ INTRODUCTION

- \* CRV 6150 and tempered
- \* Comfortable TPR handle
- \* For high used frequency workplace

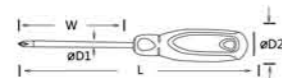

ITEM NO	SIZE mm	L mm	W mm	ØD1 mm	ØD2 mm	PCS	BARCODE
550236	PZ0X75	145	75	3	19	288	6959820852129
550237	PZ1X100	200	100	5	29	144	6959820852136
550238	PZ2X100	210	100	6	33	144	6959820852143
550239	PZ3X150	270	150	8	37	96	6959820852150

Philips Screwdriver

★ INTRODUCTION

- \* CRV and tempered
- \* Comfortable TPR handle
- \* Designed bottom for striking

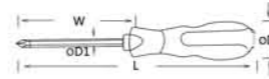

ITEM NO	SIZE mm	L mm	W mm	ØD1 mm	ØD2 mm	PCS	BARCODE
550326	PH1X100	207	100	5	30	144	6959820809635
550329	PH2X150	260	150	6	31	144	6959820809659
550332	PH3X200	320	300	8	35	144	6959820809673

Pro Screwdriver

★ INTRODUCTION

- \* CRV and tempered
- \* Comfortable TPR handle
- \* For high used frequency workplace

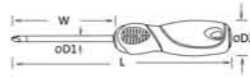

ITEM NO	SIZE mm	L mm	W mm	ØD1 mm	ØD2 mm	PCS	BARCODE
550370	PH0X75	145	75	3	20	240	6959820809796
550373	PH1X100	201	100	5	30	144	6959820809826
550375	PH2X38	99	38	6	33	144	6959820809840
550377	PH2X150	260	150	6	33	144	6959820809864
550379	PH3X200	320	200	8	37	72	6959820809888

With Soft Handle Screwdriver

★ INTRODUCTION

- \* CRV 6150 and tempered
- \* Comfortable TPR handle
- \* For high used frequency workplace

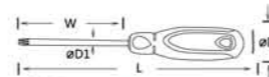

ITEM NO	SIZE mm	L mm	W mm	ØD1 mm	ØD2 mm	PCS	BARCODE
550292	T8 3X75	145	75	3	19	288	6959820852167
550293	T10 3X75	145	200	3	19	288	6959820852174
550294	T15 5X100	200	100	5	29	144	6959820852181
550295	T20 5X100	200	100	5	29	144	6959820852198
550296	T25 5X100	200	100	5	29	144	6959820852204
550297	T27 5X100	200	100	5	29	144	6959820852211
550298	T30 6X100	210	100	6	33	144	6959820852228
550299	T40 8X150	270	150	8	37	96	6959820852235

Screwdriver with Soft Handle

★ INTRODUCTION

- \* CRV 6150 and tempered
- \* Comfortable TPR handle
- \* For high used frequency workplace

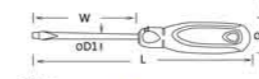

ITEM NO	SIZE mm	L mm	W mm	ØD1 mm	ØD2 mm	PCS	BARCODE
550241	3x75	145	75	3	17	288	6959820851351
550242	3x100	170	100	3	17	288	6959820851368
550243	3x150	220	150	3	17	288	6959820851375
550244	3x200	270	200	3	17	288	6959820851382
550245	5x75	175	75	5	22	144	6959820851399
550246	5x100	200	100	5	22	144	6959820851405
550247	5x125	225	125	5	22	144	6959820851412
550248	5x150	250	150	5	22	144	6959820851429
550249	5x200	300	200	5	22	144	6959820851436
550250	5x250	350	250	5	22	96	6959820851443
550251	6x38	148	38	6	30	144	6959820851450
550253	6x100	185	100	6	30	144	6959820851474
550254	6x125	210	125	6	30	144	6959820851481
550255	6x150	235	150	6	30	144	6959820851498
550256	6x200	260	200	6	30	96	6959820851504
550257	6x250	310	250	6	30	96	6959820851665
550258	6x300	410	300	6	30	96	6959820851672
550259	8x150	270	150	8	35	96	6959820851689
550260	8x200	320	200	8	35	96	6959820851696
550261	8x250	370	250	8	35	72	6959820851702

2Pc Screwdriver Set

★ INTRODUCTION

- \* 6x100mm, Ph2x100mm
- \* CRV 6150 and tempered
- \* Comfortable TPR handle



ITEM NO	PCS	BARCODE
550392	64	6959820852242

Screwdriver with Soft Handle

★ INTRODUCTION

- \* CRV 6150 and tempered
- \* Comfortable TPR handle
- \* For high used frequency workplace

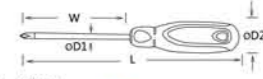

ITEM NO	SIZE mm	L mm	W mm	ØD1 mm	ØD2 mm	PCS	BARCODE
550271	PH0x75	145	75	3	17	288	6959820851719
550272	PH0x100	170	100	3	17	288	6959820851726
550273	PH0x150	220	150	3	17	288	6959820851733
550274	PH0x200	270	200	3	17	288	6959820851740
550275	PH1x75	175	75	5	22	144	6959820851757
550276	PH1x100	200	100	5	22	144	6959820851764
550277	PH1x125	225	125	5	22	144	6959820851771
550278	PH1x150	250	150	5	22	144	6959820851788
550279	PH1x200	300	200	5	22	144	6959820851795
550280	PH1x250	350	250	5	22	96	6959820851801
550281	PH2x38	148	38	6	30	144	6959820851818
550283	PH2x100	185	100	6	30	144	6959820851832
550284	PH2x125	210	125	6	30	144	6959820851849
550285	PH2x150	235	150	6	30	144	6959820851856
550286	PH2x200	260	200	6	30	96	6959820851863
550287	PH2x250	310	250	6	30	96	6959820851870
550288	PH2x300	410	300	6	30	96	6959820851887
550289	PH3x150	270	150	8	35	96	6959820851894
550290	PH3x200	320	200	8	35	96	6959820851900
550291	PH3x250	370	250	8	35	72	6959820851917

4Pc Screwdriver Set

★ INTRODUCTION

- \* 3x100, 5x100mm, Ph0x100mm, Ph1x100mm
- \* CRV 6150 and tempered
- \* Comfortable TPR handle



ITEM NO	PCS	BARCODE
550394	48	6959820852259

**10Pcs Screwdriver Set**

★ INTRODUCTION

- \*CRV and tempered
- \*Comfortable TPR handle
- \*6x38mm, 3x75mm, 5x100mm, 6x150mm
- \*PH2x38mm, PH0x75mm, PH1x100mm, PH2x150mm
- \*Tester 145mm
- \*SZ Type Screwdriver



ITEM NO	PCS	BARCODE
550395	24	6959820848283

**2 In 1 Screwdriver**

★ INTRODUCTION

- \* 2 IN 1 Screwdriver
- \* CRV and tempered
- \* PH2 and comfortable TPR handle



ITEM NO	PCS	BARCODE
550391	72	6959820809963

**9Pcs Precision Screwdriver Set**

★ INTRODUCTION

- \* 9Pcs CRV Precision Screwdriver Set
- \* Including: 1.5, 2.0, 2.5,3.0mm, PH000, PH00, PH0,T9,T10



ITEM NO	PCS	BARCODE
550122	40	6959820809239

**6Pcs Screwdriver Set**

★ INTRODUCTION

- \*3x75, 5x100mm, 6x150mm, Ph0x100mm, Ph1x100mm, Ph2x150mm
- \*CRV 6150 and tempered
- \*Comfortable TPR handle



ITEM NO	PCS	BARCODE
550396	36	6959820852266

**6Pcs Precision Screwdriver Set**

★ INTRODUCTION

- \* Swivel head handles provide precision and reach
- \* Including SL1.0,SL1.4,SL2.0,SL2.4MM,PH0,PH1



ITEM NO	PCS	BARCODE
550121	96	6959820809222

**6Pcs Precision Screwdriver Set**

★ INTRODUCTION

- \* 6Pcs CRV Precision Screwdriver Set
- \* Including: 3.0x 50mm,3.0x100mm,3.0x150mm, PH0x50mm, PH0x100mm,PH0x150mm



ITEM NO	PCS	BARCODE
550123	60	6959820809246

**45pcs Precision Screwdriver Set**

★ INTRODUCTION

- \* Material: S2 steel
- \* Torx:T3,T4,T5,T6,T7,T8,T9,T10,T15,T20.
- \* Hex:0.9,1.3,1.5,2.0,2.5,3.0,4.0
- \* U shape:2.6.
- \* Flat type:1.0,1.5,2.0,2.5,3.0,3.5,4.0.
- \* Philips type:1.5,2.0,2.5,3.0,3.5.
- \* Triangle type:3.0
- \* Repair Iphone 7 use Screw Driver Bit 2.0
- \* Repair Iphone 6 use Screw Driver Bit 1.2 and 0.8
- \* Remove chips Screw Driver Bit
- \* 7pcs socket bit : M2.5,3.0,3.5,4.0,4.5,5.0,5.5,
- \* 1pc orange (021C) and black handle precision screwdriver
- \* 1pc extension bar
- \* 1pc tweezers



ITEM NO	PCS	BARCODE
550145	48	6959820849723

**20Pcs 25MM Screwdriver bits set**

★ INTRODUCTION

- \*Slotted type
- \*S2 industrial steel
- \*Hardened and tempered
- \*Hardness: Hrc58-62
- \*Satin finished
- \*Packing: plastic case



ITEM NO	SIZE mm	L mm	ØDI mm	PCS	BARCODE
550503	SL3X25	25	3	200	6959820853218
550505	SL5X25	25	5	200	6959820853225
550506	SL6X25	25	6	200	6959820853232

**Bit parameters**

- T3,T4,T5,T6,T7,T8,T9,T10,T15,T20
- M 2.5,3.0,3.5,4.0,4.5,5.0,5.5
- 0.9,1.3,1.5,2.0,2.5,3.0,4.0
- 1.0,1.5,2.0,2.5,3.0,3.5,4.0
- 1.5,2.0,2.5,3.0,3.5
- ★ 0.8,1.2
- ▲ 3.0
- U 2.6
- ▲ 2.0
- 0.8

**Applicable to multi-type multi-standard nut**



**20Pcs 25MM Screwdriver bits set**

★ INTRODUCTION

- \*Philips type
- \*S2 industrial steel
- \*Hardened and tempered
- \*Hardness: Hrc58-62
- \*Satin finished
- \*Packing: plastic case

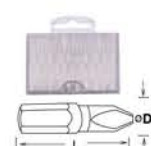

ITEM NO	SIZE mm	L mm	ØDI mm	PCS	BARCODE
550511	PHIX25	25	5	200	6959820853249
550512	PH2X25	25	6	200	6959820853256
550513	PH3X25	25	6	200	6959820853263

**20Pcs 25MM Screwdriver bits set**

★ INTRODUCTION

- \*Pozi type
- \*S2 industrial steel
- \*Hardened and tempered
- \*Hardness: Hrc58-62
- \*Satin finished
- \*Packing: plastic case



ITEM NO	SIZE mm	L mm	ØDI mm	PCS	BARCODE
550515	PZIX25	25	5	200	6959820853270
550516	PZ2X25	25	6	200	6959820853287
550518	PZ3X25	25	6	200	6959820853294

**20Pcs 25MM Screwdriver bits set**

★ INTRODUCTION

- \*Torx type
- \*S2 industrial steel
- \*Hardened and tempered
- \*Hardness: Hrc58-62
- \*Satin finished
- \*Packing: plastic case





ITEM NO	SIZE mm	L mm	ØDI mm	PCS	BARCODE
550521	T10X25	25	3	200	6959820853300
550522	T15X25	25	3.5	200	6959820853317
550523	T20X25	25	4	200	6959820853324
550525	T25X25	25	4.5	200	6959820853331
550526	T27X25	25	5.1	200	6959820853348
550527	T30X25	25	5.6	200	6959820853355
550528	T40X25	25	6.3	200	6959820853362

**20Pcs 25MM Screwdriver bits set**

★ INTRODUCTION

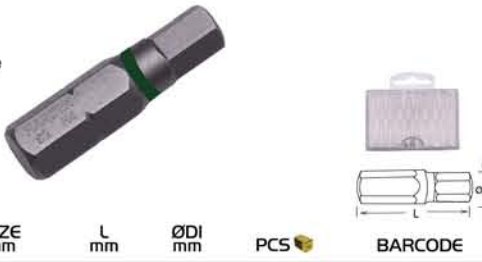
- \*Hex type
- \*S2 industrial steel
- \*Hardened and tempered
- \*Hardness: Hrc58-62
- \*Satin finished
- \*Packing: plastic case





ITEM NO	SIZE mm	L mm	ØDI mm	PCS	BARCODE
550533	H3X25	25	3.5	200	6959820853379
550534	H4X25	25	4.5	200	6959820853386
550535	H5X25	25	5.5	200	6959820853393
550536	H6X25	25	6.3	200	6959820853409

**20Pcs 25MM Screwdriver bits set**

★ INTRODUCTION

- \*Square type
- \*S2 industrial steel
- \*Hardened and tempered
- \*Hardness: Hrc58-62
- \*Satin finished
- \*Packing: plastic case

ITEM NO	SIZE mm	L mm	ØDI mm	PCS	BARCODE
550537	S1X25	25	3.6	200	6959820853416
550538	S2X25	25	4.0	200	6959820853423
550539	S3X25	25	4.8	200	6959820853430

**10Pcs 50MM Screwdriver bits set**

★ INTRODUCTION

- \*Slotted type
- \*S2 industrial steel
- \*Hardened and tempered
- \*Hardness: Hrc58-62
- \*Satin finished
- \*Packing: plastic case



ITEM NO	SIZE mm	L mm	ØDI mm	PCS	BARCODE
550553	SL3X50	50	3	200	6959820853454
550555	SL5X50	50	5	200	6959820853461
550556	SL6X50	50	6	200	6959820853478

**10Pcs 50MM Screwdriver bits set**

★ INTRODUCTION

- \*Phillips type
- \*S2 industrial steel
- \*Hardened and tempered
- \*Hardness: Hrc58-62
- \*Satin finished
- \*Packing: plastic case



ITEM NO	SIZE mm	L mm	ØDI mm	PCS	BARCODE
550561	PH1X50	50	5	200	6959820853485
550562	PH2X50	50	6	200	6959820853492
550563	PH3X50	50	6	200	6959820853508

**10Pcs 50MM Screwdriver bits set**

★ INTRODUCTION

- \*Pozi type
- \*S2 industrial steel
- \*Hardened and tempered
- \*Hardness: Hrc58-62
- \*Satin finished
- \*Packing: plastic case



ITEM NO	SIZE mm	L mm	ØDI mm	PCS	BARCODE
550565	PZIX50	50	5	200	6959820853515
550566	PZ2X50	50	6	200	6959820853522
550568	PZ3X50	50	6	200	6959820853539

**10Pcs 50MM Screwdriver bits set**

★ INTRODUCTION

- \*Hex type
- \*S2 industrial steel
- \*Hardened and tempered
- \*Hardness: Hrc58-62
- \*Satin finished
- \*Packing: plastic case





ITEM NO	SIZE mm	L mm	ØDI mm	PCS	BARCODE
550583	H3X50	50	3.5	200	6959820853614
550584	H4X50	50	4.5	200	6959820853621
550585	H5X50	50	5.5	200	6959820853638
550586	H6X50	50	6.3	200	6959820853645

**10Pcs 100MM Screwdriver bits set**

★ INTRODUCTION

- \*Phillips type
- \*S2 industrial steel
- \*Hardened and tempered
- \*Hardness: Hrc58-62
- \*Satin finished
- \*Packing: plastic case

ITEM NO	SIZE mm	L mm	ØDI mm	PCS	BARCODE
550590	PH2X100	100	6	40	6959820853683

**10Pcs 50MM Screwdriver bits set**

★ INTRODUCTION

- \*Torx type
- \*S2 industrial steel
- \*Hardened and tempered
- \*Hardness: Hrc58-62
- \*Satin finished
- \*Packing: plastic case



ITEM NO	SIZE mm	L mm	ØDI mm	PCS	BARCODE
550571	T10X50	50	3	200	6959820853546
550572	T15X50	50	3.5	200	6959820853553
550573	T20X50	50	4	200	6959820853560
550575	T25X50	50	4.5	200	6959820853577
550576	T27X50	50	5.1	200	6959820853584
550577	T30X50	50	5.6	200	6959820853591
550578	T40X50	50	6.3	200	6959820853607

**10Pcs 50MM Screwdriver bits set**

★ INTRODUCTION

- \*Square type
- \*S2 industrial steel
- \*Hardened and tempered
- \*Hardness: Hrc58-62
- \*Satin finished
- \*Packing: plastic case





ITEM NO	SIZE mm	L mm	ØDI mm	PCS	BARCODE
550588	S1X50	50	3.6	200	6959820853652
550589	S2X50	50	4.0	200	6959820853669
550590	S3X50	50	4.8	200	6959820853676

**10Pcs 150MM Screwdriver bits set**

★ INTRODUCTION

- \*Phillips type
- \*S2 industrial steel
- \*Hardened and tempered
- \*Hardness: Hrc58-62
- \*Satin finished
- \*Packing: plastic case





ITEM NO	SIZE mm	L mm	ØDI mm	PCS	BARCODE
550591	PH2X150	150	6	40	6959820853690

**10Pcs S2 Screw Driver Bit**

**★ INTRODUCTION**

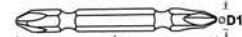
- \* 10PCS S2 Screwdriver Bit
- \* Made of high grade S2
- \* HRC 58-62



ITEM NO	SIZE mm	L mm	ØD mm	PCS	BARCODE
550603	PH2X65	65	6.35	120	6959820832800
550604	PH2X100	100	6.35	60	

**5Pcs Magnetic Nut Drivers**

**★ INTRODUCTION**

- \* Made of high grade CRV
- \* Hardened and tempered
- \* With magnetic

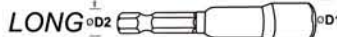

ITEM NO	SIZE mm	L mm	ØD1 mm	ØD2 mm	PCS	BARCODE
550621	6	65	6.3	10.8	40	6959820832725
550622	8	65	6.3	12.8	40	6959820832732
550624	10	65	6.3	14.8	40	6959820832749
550625	12	65	6.3	16.8	40	6959820832756
550626	14	65	6.3	17.8	40	6959820832763

**2pcs Screwdriver Bit Holder Set**

**★ INTRODUCTION**

- \* Made from CRV and Steel
- \* Length: 60mm 100mm
- \* Double blister package

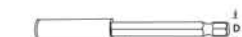

ITEM NO	SIZE mm	L mm	ØD mm	PCS	BARCODE
550702	60/100	60/100	6.3	120	6959820853867

**3pcs Hex Adaptor**

**★ INTRODUCTION**

- \*\*1/4"x65mm, 3/8"x65mm, 1/2"x70mm
- \* Made from 40CR
- \* Double blister package



ITEM NO	SIZE mm	L mm	ØD mm	PCS	BARCODE
550733	1/4"/3/8"/1/2"	65/70	6.3/10/13	100	6959820853850

**3pcs Magnetic Nut Driver**

**★ INTRODUCTION**

- \* Made of high grade CRV
- \* Hardened and tempered
- \* With magnetic



ITEM NO	SIZE mm	L mm	ØD1 mm	ØD2 mm	PCS	BARCODE
550612	8	45	6.3	12.8	120	6959820848819
550614	10	45	6.3	14.8	120	6959820848825

**14Pcs Impact Driver Set**

**★ INTRODUCTION**

- \* Bits made of CRV ,electroplating and anti-rusted
- \* Including 5pcs 8x36mm slotted bits:5,6,8,9,10mm
- \* Including 4pcs 8x36mm phillips bits:PH1,PH2,PH3,PH4
- \* Including 4pcs 8x36mm hex bits:H4,H5,H6,H8
- \* Including 1pcs impact handle with chrome plated
- \* Handle made of tools steel
- \* Tempered and durable



ITEM NO	PCS	BARCODE
550641	20	6959820810235

**1/4" Screwdriver Bit Holder With Quick Release**

**★ INTRODUCTION**

- \* Made from CRV, stainless Steel and aluminum
- \* Length: 60mm
- \* Double blister package



ITEM NO	SIZE mm	L mm	ØD mm	PCS	BARCODE
550711	60	60	6.3	120	6959820854208

**3pcs SDS-PLUS Adaptor**

**★ INTRODUCTION**

- \* Sds-Plus to 1/4", 3/8", 1/2"
- \* Made from 40CR
- \* Length: 50mm
- \* Double blister package



ITEM NO	SIZE mm	L mm	ØD mm	PCS	BARCODE
550743	1/4"/3/8"/1/2"	65/70	6.3/10/13	100	6959820853843

**PLIER & CLAMPING TOOLS**



**6" Bent Nose Plier**

★ **INTRODUCTION**



- \* Made of high carbon steel
- \* Hard, and durable sharp
- \* Fine polish and durable
- \* Two colors antislip PP handle with spring

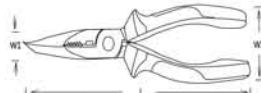

ITEM NO	SIZE	L mm	W1 mm	W2 mm	PCS	BARCODE
560146	6"	162	17	51	60	6959820854222

**Long Nose Plier**

★ **INTRODUCTION**



- \* Made of high carbon steel
- \* Hard, and durable sharp
- \* Fine polish and durable
- \* Two colors antislip PP handle with spring

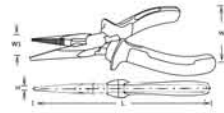

ITEM NO	SIZE	L mm	H mm	W1 mm	W2 mm	PCS	BARCODE
560156	6"	165	9.0	17.7	55	60	6959820817159
560158	8"	210	9.7	17.8	57	60	6959820817166

**Diagonal Cutting Plier**

★ **INTRODUCTION**



- \* Made of high carbon steel
- \* Hard, and durable sharp
- \* Fine polish and durable
- \* Two colors antislip PP handle with spring

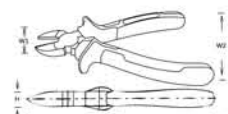

ITEM NO	SIZE	L mm	H mm	W1 mm	W2 mm	PCS	BARCODE
560166	6"	165	8.9	22.5	58	60	6959820817173
560168	8"	185	10.3	25.3	58	60	6959820817180

**Combination Plier**

★ **INTRODUCTION**



- \* Made of high carbon steel
- \* Hard, and durable sharp
- \* Fine polish and durable
- \* Two colors antislip PP handle with spring

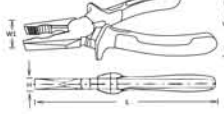

ITEM NO	SIZE	L mm	H mm	W1 mm	W2 mm	PCS	BARCODE
560176	6"	165	10.2	26.2	61	60	6959820817197
560177	7"	180	10.4	27.5	61	60	6959820817203
560178	8"	210	11.5	29.0	61	60	6959820817210

**3Pcs Plier Set**

★ **INTRODUCTION**



- \* Made of high carbon steel
- \* Hardened ,tempered and sharp
- \* 1Pc 6" long nose plier,1Pc 6" diagonal cutting plier,1Pc 8" combination plier
- \* Package: Blister card,Two colors antislip PP handle



ITEM NO	SIZE	L mm	H mm	W1 mm	W2 mm	PCS	BARCODE
560179	6"#8"	213	14	26	53.5	24	6959820851047

**Japan Type Industry Line Long Nose Plier**

★ **INTRODUCTION**



- \* Made of CRV ,high hardness and long life time
- \* Comfortable ergonomic TPR handle
- \* Hard, tartness , black finish
- \* Special design for plier head



ITEM NO	SIZE	L mm	H mm	W1 mm	W2 mm	PCS	BARCODE
560181	6"	163	9.6	18.6	53.7	60	6959820816114

**Japan Type Industry Line Diagonal Cutting Plier**

★ **INTRODUCTION**



- \* Made of CRV ,high hardness and long life time
- \* Comfortable ergonomic TPR handle
- \* Hard, tartness , sharp and black finish
- \* Special design for plier head

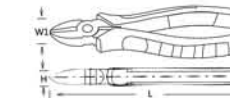

ITEM NO	SIZE	L mm	H mm	W1 mm	W2 mm	PCS	BARCODE
560183	6"	163	10.8	21	57	60	6959820816121

**Pro Long Nose Plier**

★ **INTRODUCTION**



- \* Made of fine CRV
- \* Hardened and comfortable ergonomic TPR handle
- \* Hard, tartness , sharp and black finish
- \* Black and polish finish, durable and antirust



ITEM NO	SIZE	L mm	H mm	W1 mm	W2 mm	PCS	BARCODE
560201	6"	173	8.0	16.9	55	60	6959820816145
560202	8"	205	9.5	19.2	57	60	6959820816152

**Pro Combination Plier**

★ **INTRODUCTION**



- \* Made of fine CRV
- \* Hardened and comfortable ergonomic TPR handle
- \* Hard, tartness , sharp and black finish
- \* Black and polish finish, durable and antirust

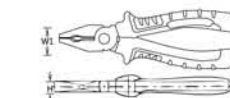

ITEM NO	SIZE	L mm	H mm	W1 mm	W2 mm	PCS	BARCODE
560226	6"	162	10.0	25.9	58	60	6959820816183
560227	7"	175	10.5	27.5	58	60	6959820851641
560228	8"	200	11.5	30.6	58	60	6959820816190

**Japan Type Industry Line Combination Plier**

★ **INTRODUCTION**



- \* Made of CRV ,high hardness and long life time
- \* Comfortable ergonomic TPR handle
- \* Hard, tartness , sharp and black finish
- \* Special design for plier head

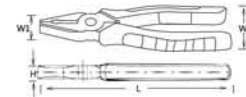

ITEM NO	SIZE	L mm	H mm	W1 mm	W2 mm	PCS	BARCODE
560187	8"	213	14	26	53.5	60	6959820816138

**Pro Diagonal Cutting Plier**

★ **INTRODUCTION**



- \* Made of fine CRV
- \* Hardened and comfortable ergonomic TPR handle
- \* Hard, tartness , sharp and black finish
- \* Black and polish finish, durable and antirust

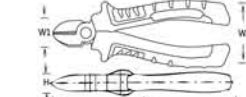

ITEM NO	SIZE	L mm	H mm	W1 mm	W2 mm	PCS	BARCODE
560211	6"	168	10.0	22.9	61.6	60	6959820816169
560212	8"	185	10.5	25.8	63.5	60	6959820816176

**Pro Bent Nose Plier**

★ **INTRODUCTION**



- \* Made of fine CRV
- \* Hardened and comfortable ergonomic TPR handle
- \* Hard, tartness , sharp and black finish
- \* Black and polish finish, durable and antirust

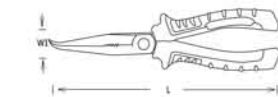

ITEM NO	SIZE	L mm	W1 mm	W2 mm	PCS	BARCODE
560231	6"	162	17	51	60	6959820817289

3Pcs Pliers Set

★ INTRODUCTION

- \*Made of fine CRV
- \*Ergonomic grip handle
- \*Hardened and tempered
- \*1pc 6" long nose plier 1pc 6" diagonal cutting plier
- \*Black finish and polish
- \*1pc 8" combination plier



ITEM NO	SIZE	L mm	H mm	PCS	BARCODE
560233	6"/8"	165	9.6	12	6959820852372

Plastic Cutter Plier

★ INTRODUCTION

- \* Made from high carbon steel
- \* The body HRC:43-48 and the cutting edge HRC56-62
- \* Apply for cutting clip, plastics gate and burr in electronics telecommunication and office stationery

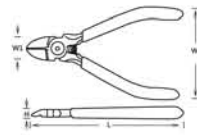

ITEM NO	SIZE	L mm	H mm	W1 mm	W2 mm	PCS	BARCODE
560281	5"	135	13	17.5	50	120	6959820817463
560282	6"	160	13	19.5	52	120	6959820817470

Electronic Plier

★ INTRODUCTION

- \* Made from high carbon steel
- \* The body HRC:43-48 and the cutting edge HRC56-62
- \* Apply for cutting clip, plastics gate and burr in electronics telecommunication and office stationery

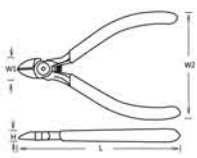

ITEM NO	SIZE	L mm	H mm	W1 mm	W2 mm	PCS	BARCODE
560286	5"	125	12.3	12.5	49	120	6959820817494

Pro Wire Stripper Plier

★ INTRODUCTION

- \* Made of fine CRV
- \* Hardened and comfortable ergonomic TPR handle
- \* Hard, tartness, sharp and black finish
- \* Black and polish finish, durable and antitrust

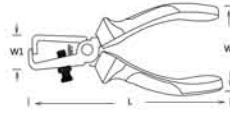

ITEM NO	SIZE	L mm	W1 mm	W2 mm	PCS	BARCODE
560235	6"	160	21	56	60	6959820817302

Electronic Plier

★ INTRODUCTION

- \* Made from high carbon steel
- \* The body HRC:43-48 and the cutting edge HRC56-62
- \* Apply for cutting clip, plastics gate and burr in electronics telecommunication and office stationery

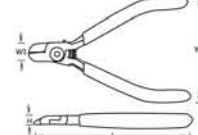

ITEM NO	SIZE	L mm	H mm	W1 mm	W2 mm	PCS	BARCODE
560285	5"	125	12.3	12.5	49	120	6959820817487

Electronic Plier

★ INTRODUCTION

- \* Made from high carbon steel
- \* The body HRC:43-48 and the cutting edge HRC56-62
- \* Apply for cutting clip, plastics gate and burr in electronics telecommunication and office stationery

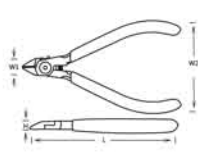

ITEM NO	SIZE	L mm	H mm	W1 mm	W2 mm	PCS	BARCODE
560287	5"	125	12.3	12.5	49	120	6959820817500

Mini Long Nose Plier

★ INTRODUCTION

- \* Made of high carbon steel
- \* High-frequency hardened and comfortable ergonomic TPR handle
- \* Durable and labor-saving

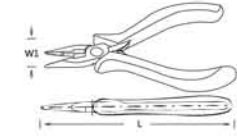

ITEM NO	SIZE	L mm	H mm	W1 mm	W2 mm	PCS	BARCODE
560301	4.5"	125	6.3	12.6	54	120	6959820816237

Mini Diagonal Cutting Plier

★ INTRODUCTION

- \* Made of high carbon steel
- \* High-frequency hardened and comfortable ergonomic TPR handle
- \* Durable and labor-saving

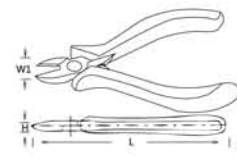

ITEM NO	SIZE	L mm	H mm	W1 mm	W2 mm	PCS	BARCODE
560303	4.5"	113	6.1	12.8	55	120	6959820816251

Mini End Cutting Plier

★ INTRODUCTION

- \* Made of quality carbon steel
- \* High-frequency hardened and comfortable ergonomic TPR handle
- \* Durable and labor-saving

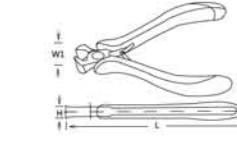

ITEM NO	SIZE	L mm	H mm	W1 mm	W2 mm	PCS	BARCODE
560305	4.5"	105	6.6	12.5	53.5	120	6959820816275

Mini Round Nose Plier

★ INTRODUCTION

- \* Made of quality carbon steel
- \* High-frequency hardened and comfortable ergonomic TPR handle
- \* Durable and labor-saving

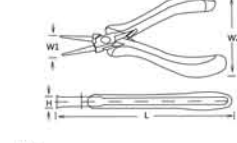

ITEM NO	SIZE	L mm	H mm	W1 mm	W2 mm	PCS	BARCODE
560307	4.5"	125	6.5	12.3	55.3	120	6959820816299

Mini Bent Long Nose Plier

★ INTRODUCTION

- \* Made of high carbon steel
- \* High-frequency hardened and comfortable ergonomic TPR handle
- \* Durable and labor-saving

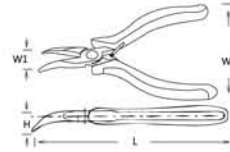

ITEM NO	SIZE	L mm	H mm	W1 mm	W2 mm	PCS	BARCODE
560302	4.5"	125	6.5	12.2	52.5	120	6959820816244

Mini Combination Plier

★ INTRODUCTION

- \* Made of quality carbon steel
- \* High-frequency hardened and comfortable ergonomic TPR handle
- \* Durable and labor-saving

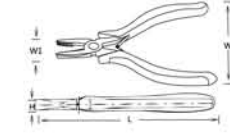

ITEM NO	SIZE	L mm	H mm	W1 mm	W2 mm	PCS	BARCODE
560304	4.5"	123	6.0	15.0	54	120	6959820816268

Mini Flat Nose Plier

★ INTRODUCTION

- \* Made of quality carbon steel
- \* High-frequency hardened and comfortable ergonomic TPR handle
- \* Durable and labor-saving

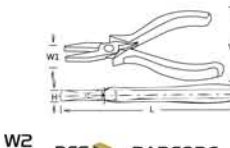

ITEM NO	SIZE	L mm	H mm	W1 mm	W2 mm	PCS	BARCODE
560306	4.5"	125	6.0	12	56	120	

Mini Lengthen Nose Plier

★ INTRODUCTION

- \* Made of quality carbon steel
- \* High-frequency hardened and comfortable ergonomic TPR handle
- \* Durable and labor-saving

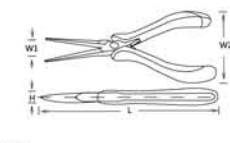

ITEM NO	SIZE	L mm	H mm	W1 mm	W2 mm	PCS	BARCODE
560308	4.5"	150	6.5	12.3	53	120	6959820816305

3Pcs Mini Pliers Set

★ INTRODUCTION

- \*Made of carton steel
- \*Nickle finish
- \*High-frequency hardened and comfortable ergonomic TPR handle



ITEM NO	SIZE	L mm	H mm	W1 mm	W2 mm	PCS	BARCODE
560309	4.5"	150	6.5	12.3	55	60	6959820852877

Slip-joint Plier

★ INTRODUCTION

- \* Drop forged CRV and high-frequency hardened
- \* Rivets design for fastening
- \* Electroplating and anti-rusted and comfortable ergonomic dipped handle

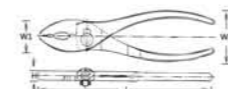

ITEM NO	SIZE	L mm	H mm	W1 mm	W2 mm	PCS	BARCODE
560401	8"	200	9.8	35	45.5	60	6959820816312

5Pcs Circlips Pliers Set

★ INTRODUCTION

- \* 5Pcs Circlips Pliers Set
- \* Multifunction pliers set including 1pcs plier, 2pcs straight head, 2pcs bent head

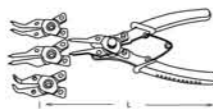

ITEM NO	SIZE	L mm	PCS	BARCODE
560501	4.5"	155	60	6959820816343

Groove Joint Plier

★ INTRODUCTION

- \* Drop forged carbon steel
- \* Electroplating and anti-rusted
- \* High-frequency hardened and comfortable ergonomic TPR handle

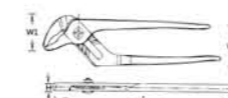

ITEM NO	SIZE	L mm	H mm	W1 mm	W2 mm	PCS	BARCODE
560411	10"	250	10.6	44	55	60	6959820816329
560412	12"	300	11.5	50	60	48	6959820816336

D4 type Groove Joint Plier

★ INTRODUCTION

- \* Drop forged carbon steel
- \* Anti-rusted
- \* High-frequency hardened and comfortable ergonomic double plastic dipped handle

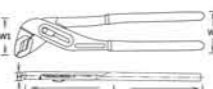

ITEM NO	SIZE	L mm	H mm	W1 mm	W2 mm	PCS	BARCODE
560421	10"	255	12	50	45	60	6959820849938

Circlip Pliers External Straight Jaw

★ INTRODUCTION

- \* Drop forged high carbon steel
- \* High-frequency hardened
- \* Fine polished and anti-rusted black finish
- \* Comfortable dipped handle

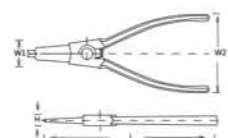

ITEM NO	SIZE	L mm	H mm	W1 mm	W2 mm	PCS	BARCODE
560504	7"	180	9.7	26	97.0	60	6959820816367
560505	9"	230	11.0	33	92.0	60	6959820817111
560506	13"	325	13.0	36	155.0	30	6959820816374

Circlip Pliers External Bent Jaw

★ INTRODUCTION

- \* Drop forged high carbon steel
- \* High-frequency hardened
- \* Fine polished and anti-rusted black finish
- \* Comfortable dipped handle

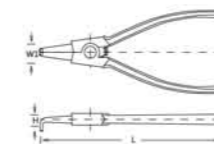

ITEM NO	SIZE	L mm	H mm	W1 mm	W2 mm	PCS	BARCODE
560509	7"	170	10	26	99	60	6959820816381
560510	9"	215	13	33	92	60	6959820817128
560511	13"	300	13	39	162	30	6959820816398

Circlip Pliers Internal Bent Jaw

★ INTRODUCTION

- \* Drop forged high carbon steel
- \* High-frequency hardened
- \* Fine polished and anti-rusted black finish
- \* Comfortable dipped handle

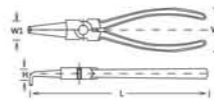

ITEM NO	SIZE	L mm	H mm	W1 mm	W2 mm	PCS	BARCODE
560519	7"	170	9.3	21	97	60	6959820816428
560520	9"	215	12.0	27	130	60	6959820817142
560521	13"	300	12.8	28	150	30	6959820816435

Welding Plier

★ INTRODUCTION

- \* Drop forged high carbon steel
- \* High-frequency hardened and Comfortable TPR handle
- \* Ideally suitable for the removal of spatter from inside, outside and the nozzle-end
- \* Perfect for removal and installation of contact tips and nozzles



ITEM NO	SIZE	L mm	H mm	W1 mm	W2 mm	PCS	BARCODE
560528	210	220	11	33	55	60	6959820816459

Circlip Pliers Internal Straight Jaw

★ INTRODUCTION

- \* Drop forged high carbon steel
- \* High-frequency hardened
- \* Fine polished and anti-rusted black finish
- \* Comfortable dipped handle

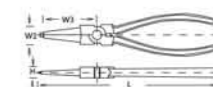

ITEM NO	SIZE	L mm	H mm	W1 mm	W2 mm	PCS	BARCODE
560514	7"	183	9.5	22	105	60	6959820816404
560515	9"	230	12.0	27	130	60	6959820817135
560516	13"	325	12.5	28	150	30	6959820816411

4pcs Circlip Pliers set

★ INTRODUCTION

- \* Drop forged high carbon steel
- \* High-frequency hardened
- \* Fine polished and anti-rusted black finish
- \* Comfortable dipped handle

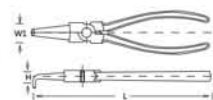

ITEM NO	SIZE	L mm	H mm	W1 mm	W2 mm	PCS	BARCODE
560524	7"	170	9.3	21	97	60	6959820852761

Carpenters Pincer

★ INTRODUCTION

- \* Drop forged CRV
- \* High-frequency hardened
- \* With two colors comfortable dipped handle

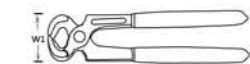

ITEM NO	SIZE	L mm	W1 mm	W2 mm	PCS	BARCODE
560535	150	150	15.0	50	60	6959820817326
560536	200	200	23.0	47	60	6959820817074
560537	250	250	28.0	55	36	6959820817333



Towers Pincer

★ INTRODUCTION

- \* Drop forged CRV
- \* High-frequency hardened
- \* With two colors comfortable dipped handle

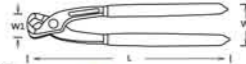

ITEM NO	SIZE	L mm	W1 mm	W2 mm	PCS	BARCODE
560531	225	225	28	52	60	6959820817043
560532	250	250	32	58	60	6959820817050
560533	300	300	26	58	36	6959820817319

Straight Jaw Lock-Grip Plier

★ INTRODUCTION

- \* Turn screw to adjust holding pressure and fit work
- \* High quality alloy steel body
- \* Special heat-treated jaw with good toughness



ITEM NO	SIZE	L mm	H mm	W1 mm	W2 mm	PCS	BARCODE
560603	7"	180	9.5	54	41	60	6959820816497
550604	10"	220	10.0	60	55	40	6959820816503

Oval Jaw Lock-Grip Plier

★ INTRODUCTION

- \* Alloy steel plate material
- \* Nickel plated



ITEM NO	SIZE	L mm	H mm	W1 mm	W2 mm	PCS	BARCODE
560628	10"	217	11	63	45.5	40	6959820817548

Lock-Grip Welding Clamp

★ INTRODUCTION

- \* Alloy steel plate material
- \* Nickel plated



ITEM NO	SIZE	L mm	H mm	W1 mm	W2 mm	PCS	BARCODE
560632	10"	230	70	67	40	36	6959820817579

End Cutting Plier

★ INTRODUCTION

- \* Forged carbon CRV
- \* High-frequency hardened
- \* With two colors comfortable dipped handle

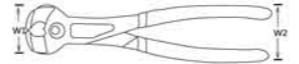

ITEM NO	SIZE	L mm	W1 mm	W2 mm	PCS	BARCODE
560540	6"	160	30	38	60	6959820848290
560542	8"	200	38	48	60	6959820848313

Long Nose Lock-Grip Plier

★ INTRODUCTION

- \* Alloy steel plate material
- \* Nickel plated



ITEM NO	SIZE	L mm	H mm	W1 mm	W2 mm	PCS	BARCODE
560622	9"	218	14	55	46	60	6959820817531

Sheet Metal Clamp

★ INTRODUCTION

- \* Alloy steel plate material
- \* Nickel plated



ITEM NO	SIZE	L mm	H mm	W1 mm	W2 mm	PCS	BARCODE
560631	10"	248	18	69	51	36	6959820817555

Chain Lock-Grip Plier

★ INTRODUCTION

- \* Alloy steel plate material
- \* Nickel plated



ITEM NO	SIZE	L mm	H mm	W1 mm	W2 mm	PCS	BARCODE
560633	18"	220	19	63	56	36	6959820817562

C-Clamp Lock-Grip Plier

★ INTRODUCTION

- \* Alloy steel plate material
- \* Nickel plated
- \* Adjustable clamp mouth

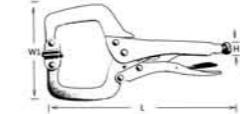

ITEM NO	SIZE	L mm	H mm	W1 mm	W2 mm	PCS	BARCODE
560635	11"	275	18.8	127	51	36	6959820817586

Pro Rotary Punch

★ INTRODUCTION

- \* Size: 250mm
- \* 5 different hole sizes: 2, 2.5, 3, 3.5, 4, 4.5mm
- \* Perfect for leather belts, canvas and fabric with an adjustable cutting head



ITEM NO	SIZE	L mm	W mm	PCS	BARCODE
560710	250	250	78	50	6959820830011

Pro Rotary Punch

★ INTRODUCTION

- \* #45 carbon steel punching head, blacked and heat treated
- \* Hole size: round hole: 3.5mm, 4mm, 4.5mm  
flat hole: 6.6x3.1mm, 7.5x3.6mm  
oval hole: 6.1x4mm



- \* Necessary tool in factory, store, office and hotel and widely used in punching round holes into soft materials, leather, canvas, rubber, plastic and cardboard



ITEM NO	SIZE	L mm	W mm	PCS	BARCODE
560714	10"	252	80	50	6959820847262

C-Clamp Lock-Grip Plier

★ INTRODUCTION

- \* Alloy steel plate material
- \* Nickel plated
- \* Adjustable clamp mouth

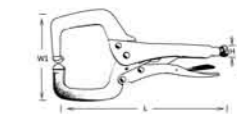

ITEM NO	SIZE	L mm	H mm	W1 mm	W2 mm	PCS	BARCODE
560638	11"	275	18.8	127	51	36	6959820817593

Pro Rotary Punch

★ INTRODUCTION

- \* #45 carbon steel punching head, blacked and heat treated
- \* Hole size: round hole: 3.5mm, 4mm, 4.5mm flat hole: 7x3mm, 8x3mm  
oval hole: 6x4.5mm
- \* Necessary tool in factory, store, office and hotel and widely used in punching round holes into soft materials, leather, canvas, rubber, plastic and cardboard



ITEM NO	SIZE	L mm	W mm	PCS	BARCODE
560712	250	250	78	50	6959820847170

Pro Rotary Punch

★ INTRODUCTION

- \* #45 carbon steel punching head, blacked and heat treated
- \* Hole size: round hole: 3.5mm, 4mm, 4.5mm  
flat hole: 6.6x3.1mm, 7.5x3.6mm  
oval hole: 6.1x4mm



- \* Necessary tool in factory, store, office and hotel and widely used in punching round holes into soft materials, leather, canvas, rubber, plastic and cardboard

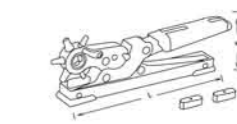

ITEM NO	SIZE	L mm	W mm	PCS	BARCODE
560715	10"	217	178	50	6959820847279



## Mini Bolt Cutter

### ★ INTRODUCTION



- \* T8 alloy steel blades
- \* Heat-treated blades
- \* Comfortable ergonomics handle
- \* Do not cut products which hardness is more than HRC42

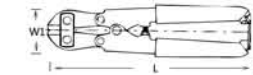

ITEM NO	SIZE	L mm	W1 mm	W2 mm	RANGE mm	PCS	BARCODE
570001	8"	210	42	60	Ø 3.17(1/8")	60	6959820816596

## Bolt Cutter Spare

### ★ INTRODUCTION



- \* T8 alloy steel blades
- \* Heat-treated blades
- \* Comfortable ergonomics handle
- \* Do not cut products which hardness is more than HRC42



ITEM NO	SIZE	PCS	BARCODE
570024	24"	16	6959820817395
570025	30"	12	6959820817401
570026	36"	12	6959820817418
570027	42"	12	6959820817425

## Cable Cutter

### ★ INTRODUCTION



- \* Hardened high carbon steel cutting blades
- \* Can quick and easily cutting copper and Aluminum cables
- \* Steel handle with rubber grips

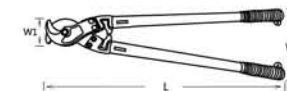

ITEM NO	SIZE	L mm	W1 mm	W2 mm	RANGE mm	PCS	BARCODE
570071	18"	450	50	150	150	12	6959820832657
570072	24"	600	58	133	250	10	6959820832664
570073	32"	800	85	160	400	5	6959820832671
570075	36"	900	85	190	450	5	6959820832688
570076	42"	1050	100	190	500	4	6959820832695

## Bolt Cutter

### ★ INTRODUCTION



- \* T8 alloy steel blades
- \* Heat-treated blades
- \* Comfortable ergonomics handle
- \* Do not cut products which hardness is more than HRC42

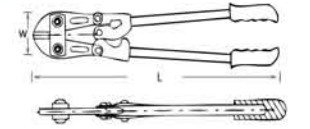

ITEM NO	SIZE	L mm	W mm	low carbon steel	medium carbon steel	PCS	BARCODE
570011	12"	300	50	Ø 5(3/16")	Ø 4(5/12")	30	6959820816602
570012	14"	350	55	Ø 7(1/4")	Ø 5(3/16")	30	6959820816619
570013	18"	450	65	Ø 8(5/16")	Ø 6(1/4")	20	6959820816626
570014	24"	600	80	Ø 10(3/8")	Ø 8(5/16")	10	6959820816633
570015	30"	750	100	Ø 13(1/2")	Ø 10(3/8")	5	6959820816640
570016	36"	900	105	Ø 16(5/8")	Ø 13(7/16")	5	6959820816657
570017	42"	1050	110	Ø 19(3/4")	Ø 16(9/16")	3	6959820816664

## Wire Rope Cutter

### ★ INTRODUCTION



- \* Drop forged T8 steel blade, heat treated
- \* Used to cut steel and stainless steel wire rope
- \* Comfortable rubber grip handle

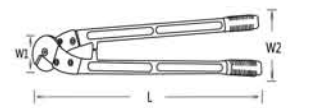

ITEM NO	SIZE	L mm	W1 mm	W2 mm	RANGE mm	PCS	BARCODE
570063	24"	600	70	145	Ø 12(15/32")	10	6959820832633
570065	36"	900	90	200	Ø 14(9/16")	5	6959820832640

## Cable Cutter

### ★ INTRODUCTION



- \* 55 # overall forging
- \* Heat-treated blades
- \* Comfortable ergonomics handle

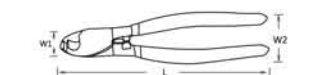

ITEM NO	SIZE	L mm	W1 mm	W2 mm	RANGE mm	PCS	BARCODE
570066	6"	600	70	145	Ø 0.8-1.2	60	6959820849914
570068	8"	900	90	200	Ø 0.8-1.2	36	6959820849921

Aviation Snips Left

★ INTRODUCTION



- \* High quality alloy steel
- \* Heat treated blade
- \* Cutting ability: max 1.25mm cold rolling iron sheet and 0.8mm stainless steel sheet
- \* Ergonomic comfortable grip handle

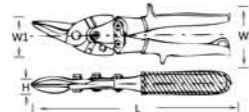

ITEM NO	SIZE	L mm	H mm	W1 mm	W2 mm	PCS	BARCODE
570101	10"	250	23	57	60	48	6959820816671

Aviation Snips Right

★ INTRODUCTION



- \* High quality alloy steel
- \* Heat treated blade
- \* Cutting ability: max 1.25mm cold rolling iron sheet and 0.8mm stainless steel sheet
- \* Ergonomic comfortable grip handle

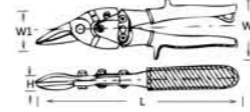

ITEM NO	SIZE	L mm	H mm	W1 mm	W2 mm	PCS	BARCODE
570102	10"	250	22	57	60	48	6959820816688

Aviation Snips Straight

★ INTRODUCTION



- \* High quality alloy steel
- \* Heat treated blade
- \* Cutting ability: max 1.25mm cold rolling iron sheet and 0.8mm stainless steel sheet
- \* Ergonomic comfortable grip handle

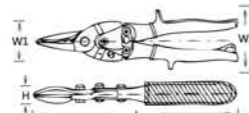

ITEM NO	SIZE	L mm	H mm	W1 mm	W2 mm	PCS	BARCODE
570103	10"	250	22	57	60	48	6959820816695

Taiwan Type Aviation Snips Left

★ INTRODUCTION



- \* High quality CRV
- \* Heat treated blade
- \* Cutting ability: max 1.25mm cold rolling iron sheet and 0.8mm stainless steel sheet
- \* Ergonomic comfortable grip handle

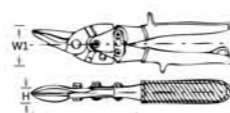

ITEM NO	SIZE	L mm	H mm	W1 mm	W2 mm	PCS	BARCODE
570105	10"	250	23	57	48	48	6959820817364

Taiwan Type Aviation Snips Right

★ INTRODUCTION



- \* High quality CRV
- \* Heat treated blade
- \* Cutting ability: max 1.25mm cold rolling iron sheet and 0.8mm stainless steel sheet
- \* Ergonomic comfortable grip handle

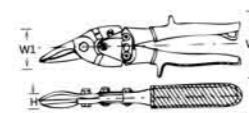

ITEM NO	SIZE	L mm	H mm	W1 mm	W2 mm	PCS	BARCODE
570106	10"	250	22	57	60	48	6959820817371

Taiwan Type Aviation Snips Straight

★ INTRODUCTION



- \* High quality CRV
- \* Heat treated blade
- \* Cutting ability: max 1.25mm cold rolling iron sheet and 0.8mm stainless steel sheet
- \* Ergonomic comfortable grip handle

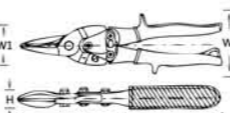

ITEM NO	SIZE	L mm	H mm	W1 mm	PCS	BARCODE
570107	10"	250	22	57	48	6959820817388

Straight Pattern Tinsnips

★ INTRODUCTION



- \* Drop forged Chrome vanadium steel
- \* Heat treated blade
- \* Full polished body
- \* Comfortable handle, easy to use

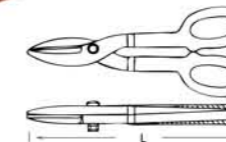

ITEM NO	SIZE	L mm	COLD mm	STAINLESS mm	PCS	BARCODE
570111	10"	255	0.8	0.5	36	6959820816701
570113	12"	300	1.0	0.7	36	6959820816718

Knife Metal Holder

★ INTRODUCTION



- \* High impact ABS housing, metal flute for strength, 0.4mm thick blade
- \* Including 1pc blade;
- \* It could be used in conjunction with HARDEN #570341 blade.



ITEM NO	SIZE mm	L mm	W mm	PCS	BARCODE
570301	9	125	16	600	6959820816800

Plastic Knife

★ INTRODUCTION



- \* High quality PP housing, metal flute for strength
- \* Including 1pc blade
- \* It could be used with HARDEN #570343 blade

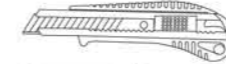

ITEM NO	SIZE(mm)	L(mm)	W(mm)	PCS	BARCODE
570306	18	150	48	144	6959820817340

Germany Type Tin Cutter

★ INTRODUCTION



- \* Drop forged Chrome vanadium steel
- \* Heat treated blade
- \* Cutting ability: max 1.2mm cold rolling iron sheet and 0.7mm stainless steel sheet
- \* Comfortable handle



ITEM NO	SIZE	L mm	COLD mm	STAINLESS mm	PCS	BARCODE
570135	8"	200	Ø 1.20	Ø 0.7	36	6959820817432
570136	10"	250	Ø 1.20	Ø 0.7	36	6959820817449
570137	12"	300	Ø 1.20	Ø 0.7	36	6959820817456

Pro Heavy Duty Zinc Alloy Knife

★ INTRODUCTION



- \* High quality zinc alloy housing, metal flute for strength
- \* Including 1pc blade
- \* It could be used with HARDEN #570343 blade



ITEM NO	SIZE(mm)	L(mm)	W(mm)	PCS	BARCODE
570302	18	160	27	108	6959820816817

Aluminum Alloy Knife

★ INTRODUCTION



- \* Aluminum alloy housing, metal flute for strength
- \* Including 1pc blade
- \* It could be used with HARDEN #570343 blade

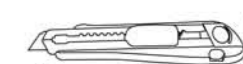

ITEM NO	SIZE(mm)	L(mm)	W(mm)	PCS	BARCODE
570307	18	180	27	144	6959820849686

Plastic Knife Metal Holder 3Pcs Blade

★ INTRODUCTION



- \* High quality PP housing, metal flute for strength
- \* Including 3pc blade
- \* It could be used with HARDEN #570343 blade

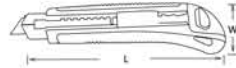

ITEM NO	SIZE(mm)	L(mm)	W(mm)	PCS	BARCODE
570312	18	170	45	144	6959820816831

Universal Knife

★ INTRODUCTION



- \* Aluminum housing, Grilled metallic paint, durable and good-looking
- \* Special design, more convenient and labor-saving
- \* Including 1pc blade
- \* It could be used with HARDEN #570345 blade



ITEM NO	L(mm)	W(mm)	PCS	BARCODE
570321	150	32	144	6959820816848

Universal Knife

★ INTRODUCTION



- \* zinc alloy housing, Grilled metallic paint, durable and good-looking
- \* Special design, more convenient and labor-saving
- \* Including 1pc blade
- \* It could be used with HARDEN #570345 blade



ITEM NO	L(mm)	W(mm)	PCS	BARCODE
570323	150	30	144	6959820816862

Universal Knife

★ INTRODUCTION



- \* Zinc alloy housing, Grilled metallic paint, durable and good-looking
- \* Special design, more convenient and labor-saving
- \* Including 1pc blade
- \* It could be used in HARDEN #570345 blade

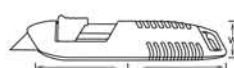

ITEM NO	SIZE(mm)	L(mm)	W(mm)	PCS	BARCODE
570325	18	165	32	144	6959820816879

Pro Metal Knife 6Pcs Blade

★ INTRODUCTION



- \* Zinc alloy housing, Grilled metallic paint, durable and good-looking
- \* Special design, more convenient and labor-saving
- \* Including 1pc blade
- \* It could be used with HARDEN #570345 blade

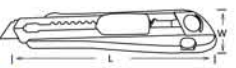

ITEM NO	SIZE(mm)	L(mm)	W(mm)	PCS	BARCODE
570331	18	175	38	96	6959820816886

Folding Knife

★ INTRODUCTION



- \* Aluminum alloy handle and housing
- \* Safety lock-back system
- \* Quick change blade mechanism
- \* Including 5pcs blades
- \* Advice to use #570345 blade

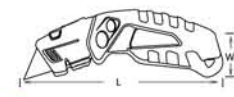

ITEM NO	SIZE(mm)	L(mm)	W(mm)	PCS	BARCODE
570332	165	165	33	96	6959820850590

Heavy Duty Metal Knife

★ INTRODUCTION



- \* Aluminum alloy housing
- \* Stainless steel flute for strength
- \* Including 1pc 25mm blade
- \* It could be used with HARDEN #570349 blade

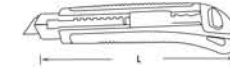

ITEM NO	SIZE(mm)	L(mm)	W(mm)	PCS	BARCODE
570335	25X200	200	45	72	6959820850842

10Pcs 18x100mm Knife Blade

★ INTRODUCTION



- \* 10Pcs 18x100mm Knife Blade
- \* Razor-sharp SK5 blade
- \* 10pcs per plastic box



ITEM NO	L(mm)	W(mm)	T(mm)	PCS	BARCODE
570343	97	18	0.6	240	6959820816916

10Pcs 9x80mm Knife Blade

★ INTRODUCTION



- \* 10Pcs 9x80mm Knife Blade
- \* Razor-sharp SK5 blade
- \* 10pcs per plastic box



ITEM NO	L(mm)	W(mm)	T(mm)	PCS	BARCODE
570341	80	9	0.4	400	6959820816893

10Pcs Universal Knife Blade

★ INTRODUCTION



- \* Razor-sharp SK5 blade
- \* 10pcs per plastic box



ITEM NO	L(mm)	W(mm)	T(mm)	PCS	BARCODE
570345	60	18.3	0.52	400	6959820816923

10Pcs 25x125mm Knife Blade

★ INTRODUCTION



- \* 0.7mm thickness blade
- \* Razor-sharp SK5 steel
- \* 7 segment small edges #570335



ITEM NO	SIZE	L mm	W mm	PCS	BARCODE
570349	25mm	125mm	25mm	100	6959820851634

Auto-oil Glass Cutter

★ INTRODUCTION



- \* Glass cutter with PS handle
- \* YG8 cutter wheel
- \* Chrome plated cutter
- \* Cutting ability: 2-12mm thick glass



ITEM NO	SIZE(mm)	L(mm)	W1(mm)	W2(mm)	PCS	BARCODE
570351	175	175	14	14	120	6959820817012

## Auto-oil Glass Cutter

### ★ INTRODUCTION

- \* Glass cutter with metal handle
- \* YG8 cutter wheel
- \* Chrome plated cutter
- \* Cutting ability: 2-12mm thick glass

YG8  



ITEM NO	SIZE(mm)	L(mm)	W1(mm)	W2(mm)	PCS	BARCODE
570352	175	175	14	14	120	6959820817029

## Stainless Steel Scissors

### ★ INTRODUCTION

- \* Stainless Steel Scissors
- \* Made of high quality stainless steel, 2mm thick;
- \* Ergonomic comfortable ABS handle

STAINLESS  



ITEM NO	SIZE(mm)	L(mm)	W1(mm)	W2(mm)	PCS	BARCODE
570361	200	200	21	87	180	6959820816930

## Multi-purpose Scissors

### ★ INTRODUCTION

- \* Made of high quality stainless steel;
- \* Heat treated, HRC52-56
- \* Used for the cutting of thin iron sheet, aluminum alloy, cables(22mm for soft cable), etc.

STAINLESS  

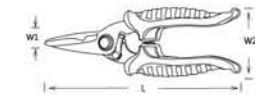

ITEM NO	SIZE(mm)	L(mm)	W1(mm)	W2(mm)	PCS	BARCODE
570363	180	180	16	55	72	6959820817357

## Pro Auto-oil Glass Cutter

### ★ INTRODUCTION

- \* Glass cutter with aluminum handle
- \* YD05 tungsten carbide, cutter wheel
- \* Chrome plated cutter
- \* Cutting ability: 5-15mm thick glass

A-ALLOY   

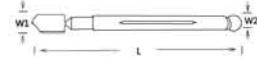

ITEM NO	SIZE(mm)	L(mm)	W1(mm)	W2(mm)	PCS	BARCODE
570353	185	185	15	15	120	6959820817036

## Multi-purpose Scissors

### ★ INTRODUCTION

- \* Multi-Purpose Scissors
- \* Made of high quality stainless steel, 3mm thick;
- \* Ergonomic comfortable ABS handle

STAINLESS  

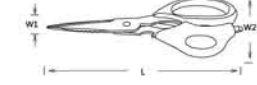

ITEM NO	SIZE(mm)	L(mm)	W1(mm)	W2(mm)	PCS	BARCODE
570362	220	220	21	98	72	6959820816947

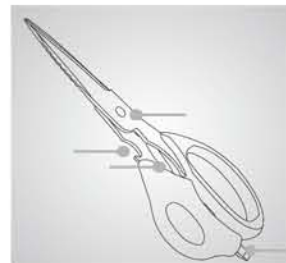

Handle pull bottom to remove  
Clamping hard objects, bottle  
openers, picking objects

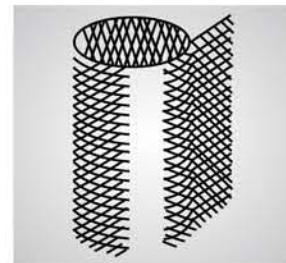

Rete in ferro 0.5mm  
iron wire net 0.5mm



Cuoio comune  
ordinary leather.



Rete da pesca  
fishing net.



# MEASURE TOOLS

**Measuring Tape**

★ INTRODUCTION

- \* High impact ABS case with rubber cover
- \* Heat-treated spring provides long life and smooth blade rewind
- \* Strong belt clip



ITEM NO	SIZE	L1(mm)	L2(mm)	PCS	BARCODE
580006	3.0mx19mm	60	19	120	6959820822283
580007	5.0mx19mm	70	19	120	6959820822290
580008	5.0mx25mm	70	25	96	6959820822306
580009	7.5mx25mm	80	25	60	6959820822313
580010	10mx25mm	90	25	48	6959820822320

**Long Measuring Tape**

★ INTRODUCTION

- \* Fiberglass tape, with clear and durable graduation;
- \* High impact ABS case;
- \* Strong belt clip



ITEM NO	SIZE	L1(mm)	L2(mm)	W(mm)	PCS	BARCODE
580202	20mx12.5mm	123	12.5	133	60	6959820821101
580203	30mx12.5mm	158	12.5	165	40	6959820821118

**Steel Measuring Tape**

★ INTRODUCTION

- \* High quality nickel plated blade;
- \* With clear and durable graduation;
- \* High impact steel case;



ITEM NO	SIZE(mm)	L(mm)	W(mm)	PCS	BARCODE
580225	50	180	320	16	6959820832701
580230	100	210	340	12	6959820832718

**Measuring Tape**

★ INTRODUCTION

- \* Impact resistant rubberized case
- \* Heat-treated spring provides long life and smooth blade rewind
- \* Strong belt clip



ITEM NO	SIZE	L1(mm)	L2(mm)	PCS	BARCODE
580033	3.0mx16mm	70	16	120	6959820821941
580035	5.0mx19mm	81	19	120	6959820821958
580036	5.0mx25mm	81	25	96	6959820821965
580037	7.5mx25mm	83	25	60	6959820821972

**Long Measuring Tape**

★ INTRODUCTION

- \* Fiberglass tape, with clear and durable graduation;
- \* High impact ABS case;
- \* Strong belt clip
- \* Ergonomics comfortable grip;



ITEM NO	SIZE(mm)	L1(mm)	L2(mm)	W(mm)	PCS	BARCODE
580213	30mx12.5mm	180	12.5	320	20	6959820821125
580215	50mx12.5mm	225	12.5	370	20	6959820821132
580217	100mx12.5mm	307	12.5	455	10	6959820822269

**52Pcs Screw-pitch Gauge**

★ INTRODUCTION

- \*Stainless steel blade, surface polished
- \*Size: Metric: 0.25-6.0mm(0.25,0.3,0.35,0.4,0.45,0.5,0.6,0.7,0.75, 0.8,0.9,1.0,1.25,1.5,1.75,2.0,2.5,3.0,3.5,4.0,4.5,5.0,5.5,6.0mm)
- Whitworth: 4-62(4,4.5,5,6,7,8,9,10,11,12,13,14,15,16,18,20,22, 24,25,26,28,30,32,36,40,48,60,62)



ITEM NO	PCS	BARCODE
580412	100	6959820852624

**32Pcs Feeler Gauge**

★ INTRODUCTION

- \* 65Mn blade, surface polished
- \* FeelerSize:0.04,0.05,0.06,0.08,0.10,0.13,0.15,0.18,0.20,0.23,0.25, 0.28,0.30,0.33,0.35,0.38,0.40,0.43,0.45,0.48,0.50,0.53,0.55,0.58, 0.60,0.63,0.65,0.70,0.75,0.80,0.88+0.25mm Copper Sheet



ITEM NO	PCS	BARCODE
580432	72	6959820821170

**Torpedo Level With Magnet**

★ INTRODUCTION

- \* Torpedo level with magnetic
- \* ABS case with aluminum rail
- \* 3 high visible vials

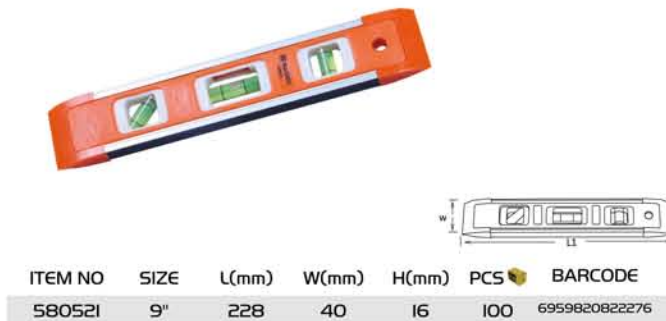

ITEM NO	SIZE	L(mm)	W(mm)	H(mm)	PCS	BARCODE
580521	9"	228	40	16	100	6959820822276

**Aluminium Level**

★ INTRODUCTION

- \* Aluminium Three Vials Level
- \* Aluminum frame;
- \* Comfortable rubber handle
- \* 3 high visible vials



ITEM NO	SIZE(mm)	L(mm)	W(mm)	H(mm)	PCS	BARCODE
580511	600	600	58	23.5	30	6959820821217
580512	800	800	58	23.5	30	6959820821224
580513	1000	1000	58	23.5	30	6959820821231

**15Pcs Feeler Gauge**

★ INTRODUCTION

- \* 65Mn blade, surface polished
- \* FeelerSize:0.051,0.076,0.102,0.127,0.152,0.203,0.279,0.305,0.330, 0.356,0.406,0.457,0.508,0.559,0.635mm,1x Gauge Sheet



ITEM NO	PCS	BARCODE
580415	120	6959820821163

**Torpedo Aluminum Level With Magnet**

★ INTRODUCTION

- \* Cast aluminum body
- \* Three high visible vials
- \* Two pieces strong magnet

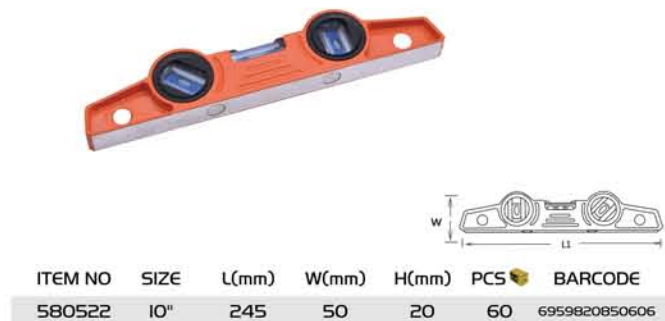

ITEM NO	SIZE	L(mm)	W(mm)	H(mm)	PCS	BARCODE
580522	10"	245	50	20	60	6959820850606

**Aluminium Level**

★ INTRODUCTION

- \* Aluminium Three Vials Level
- \* Aluminum frame;
- \* Comfortable rubber handle
- \* 3 high visible vials

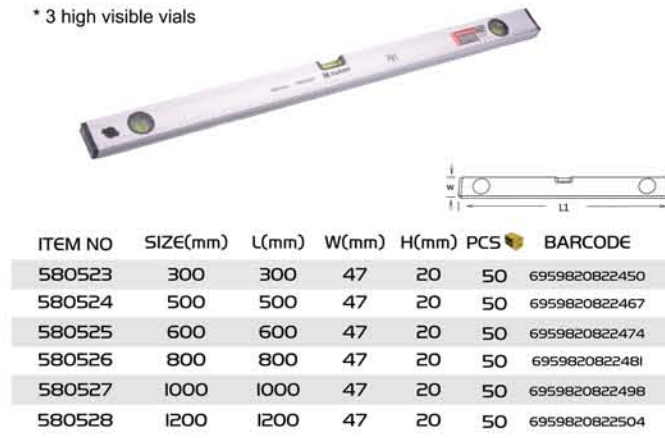

ITEM NO	SIZE(mm)	L(mm)	W(mm)	H(mm)	PCS	BARCODE
580523	300	300	47	20	50	6959820822450
580524	500	500	47	20	50	6959820822467
580525	600	600	47	20	50	6959820822474
580526	800	800	47	20	50	6959820822481
580527	1000	1000	47	20	50	6959820822498
580528	1200	1200	47	20	50	6959820822504

**Stainless Steel Ruler**

★ INTRODUCTION

- \* Stainless steel
- \* Easy to read
- \* Suitable for industrial use



ITEMNO	SIZE(mm)	PCS	BARCODE
580701	150	500	6959820821255
580703	300	300	6959820821262
580705	500	200	6959820821279
580707	1000	100	6959820821286
580708	1200	60	6959820821910
580709	1500	30	6959820821927
580710	2000	30	6959820821934

**Bevel Ptractor**

★ INTRODUCTION

- \* High quality stainless steel, hardness no less than HRC30
- \* Metric scale, 180 degree swiveled
- \* Embossed graduation for easy reading and durability

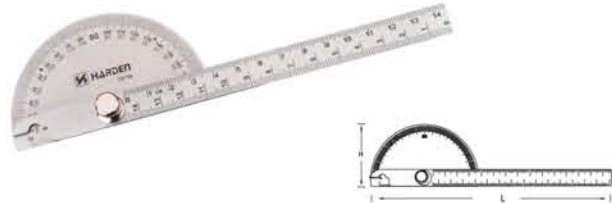

ITEMNO	SIZE(mm)	L(mm)	H(mm)	PCS	BARCODE
580718	90X150	197	52	120	6959820832565

**Triangle Square**

★ INTRODUCTION

- \* High quality stainless steel, hardness no less than HRC30
- \* Aluminum alloy base
- \* Embossed graduation for easy reading and durability



ITEM NO	SIZE(mm)	PCS	BARCODE
580726	150	80	6959820832589
580727	200	80	6959820832596

**Aluminium Try Square**

★ INTRODUCTION

- \* High quality aluminum stock
- \* Durable and clear graduation scale
- \* Suitable for industrial



ITEMNO	SIZE(mm)	PCS	BARCODE
580712	250	100	6959820821293
580713	300	100	6959820821309
580714	400	60	6959820821316

**Combination Square**

★ INTRODUCTION

- \* High quality stainless steel, hardness no less than HRC30
- \* Aluminum alloy body
- \* Embossed graduation for easy reading and durability
- \* With impact-resistant vial



ITEM NO	SIZE(mm)	L(mm)	PCS	BARCODE
580720	300	300	60	6959820832572

**Stainless Steel Square**

★ INTRODUCTION

- \* High quality stainless steel, hardness no less than HRC30
- \* Embossed graduation for easy reading and durability



ITEM NO	SIZE(mm)	L(mm)	W(mm)	PCS	BARCODE
580728	150x300	300	150	100	6959820832602
580729	250x500	500	250	100	6959820832619

**Vernier caliper**

★ INTRODUCTION

- \* Caliper for measuring inner diameter, diameter, with depth and step function
- \* Rule body scale using laser engraving process, clear scale
- \* Satin finish



ITEM NO	SIZE(mm)	L(mm)	W1(mm)	W2(mm)	PCS	BARCODE
580804	150	230	77	16	50	6959820822337
580805	200	300	77	16	50	6959820822344

**Digital Caliper**

★ INTRODUCTION

- \* Made of stainless steel
- \* Super extra high LCD display, powered by battery, metric and inch interchangeable
- \* Caliper for measuring inner diameter, diameter, with depth and step function



ITEM NO	SIZE(mm)	L(mm)	W1(mm)	W2(mm)	PCS	BARCODE
580821	150	235	77	16	50	6959820821354

**Green Line Laser Level**

★ INTRODUCTION

- \* 2 Osrsm green lines
- \* Wavelength: 520Nm laser diode
- \* Swaying rest time: 4Seconds
- \* Damping Level: Automatic
- \* Accuracy: 10m±2mm
- \* Dustproof and waterproof rating: IP54
- \* Work temperature: -10°C~+50°C
- \* Stock temperature: -20°C~+80°C
- \* 3Pcs AA 1.5V battery
- \* 1Pc clamp support
- \* 3Pcs alkaline battery
- \* Packing: Nylon bag + Color box



10 METRE

- self-leveling
- Recordable & rotatable
- Tripodready

ITEM NO	SIZE(Nm)	L(mm)	W1(mm)	W2(mm)	PCS	BARCODE
581002	520Nm	235	77	16	24	6959820852914

**Dial Caliper**

★ INTRODUCTION

- \* Made of stainless steel
- \* Caliper for measuring inner diameter, diameter, with depth and step function
- \* Meet or exceeds DIN862, division value: 0.02mm



ITEM NO	SIZE(mm)	L(mm)	W1(mm)	W2(mm)	PCS	BARCODE
580811	150	235	77	16	50	6959820821347

**Microcalliper**

★ INTRODUCTION

- \* For measuring outer diameter of items, accuracy higher than venier caliper
- \* Division value: 0.01mm
- \* Laser engraving scale, clear and durable

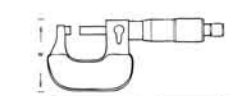

ITEM NO	SIZE(mm)	L(mm)	W(mm)	PCS	BARCODE
580832	0-25	135	103	50	6959820821361
580835	25-50	160	116	50	6959820821378

# STRIKING TOOLS



## Machinist Hammer with Wood Handle

### ★ INTRODUCTION



- \* Forged fine steel head hardened, tempered. HRC>48
- \* Matt black powder painted head
- \* High quality oak

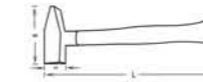

ITEM NO	SIZE(g)	L(mm)	W(mm)	H(mm)	PCS	BARCODE
590011	100	275	82	15	120	6959820849129
590013	300	300	105	23	48	6959820849136
590015	500	330	120	27	24	6959820849143
590018	800	350	130	33	24	6959820849150
590020	1000	360	135	36	12	6959820849167
590025	1500	400	145	42	12	6959820849174

## Stoning Hammer With Wood Handle

### ★ INTRODUCTION



- \* Forged fine grain steel head hardened, tempered. HRC>48
- \* Matt black powder painted head.
- \* High quality oak

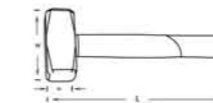

ITEM NO	SIZE(kg)	L(mm)	W(mm)	H(mm)	PCS	BARCODE
590051	1.0	260	95	40	24	6959820853911
590055	1.5	280	110	45	12	6959820853928
590060	2.0	300	120	50	12	6959820853935

## Stoning Hammer Fiberglass Handle

### ★ INTRODUCTION



- \* Forged fine grain steel head hardened, HRC>48
- \* Matt black painted head
- \* Two colors fiberglass shaft with comfortable ergonomics cushion grip

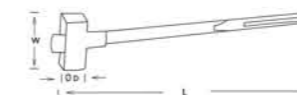

ITEM NO	SIZE(kg)	L(mm)	W(mm)	H(mm)	PCS	BARCODE
590083	3	900	140	57	4	6959820822108
590084	4	900	150	62	4	6959820822115
590085	5	900	160	68	2	6959820822122

## Machinist Hammer with Fiberglass Handle

### ★ INTRODUCTION



- \* Forged fine grain steel head hardened, tempered. HRC>48
- \* Matt black powder painted head
- \* Two colors fiberglass shaft with comfortable ergonomics cushion grip

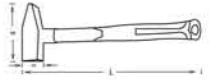

ITEM NO	SIZE(kg)	L(mm)	W(mm)	H(mm)	PCS	BARCODE
590031	0.1	275	82	15	120	6959820821989
590032	0.2	279	95	19	60	6959820821996
590033	0.3	300	105	23	48	6959820822009
590034	0.4	302	112	25	30	6959820822016
590035	0.5	333	118	27	24	6959820822023
590036	0.6	335	122	29	24	6959820822030
590038	0.8	357	130	33	24	6959820822047
590040	1.0	360	135	36	12	6959820822054
590045	1.5	403	145	42	12	6959820822061

## Stoning Hammer W Fiberglass Handle

### ★ INTRODUCTION



- \* Forged fine grain steel head hardened, tempered. HRC>48
- \* Matt black powder painted head
- \* Two colors fiberglass shaft with comfortable ergonomics cushion grip

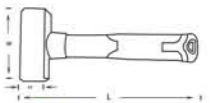

ITEM NO	SIZE(kg)	L(mm)	W(mm)	H(mm)	PCS	BARCODE
590061	1.0	255	95	40	24	6959820822078
590065	1.5	280	110	45	12	6959820822085
590070	2.0	284	120	50	12	6959820822092

## Ball Pein Hammer Fiberglass Handle

### ★ INTRODUCTION



- \* Forged fine grain steel head hardened, HRC>48
- \* Fully ground face and cheeks
- \* Two colors fiberglass shaft with comfortable ergonomics cushion grip.

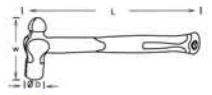

ITEM NO	SIZE(kg)	L(mm)	W(mm)	ØD(mm)	PCS	BARCODE
590114	0.45	317.5	100.0	29.3	24	6959820821415
590116	0.68	360.0	116.0	34.0	24	6959820821422
590119	0.91	345.0	125.5	34.0	24	6959820821439



**Ball Pein Hammer Oak Wood Handle**

★ INTRODUCTION

- \* Forged fine grain steel head hardened.HRC>48
- \* Fully ground face and cheeks
- \* High quality oak wood handle

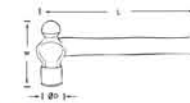

ITEM NO	SIZE(kg)	L(mm)	W(mm)	ØD(mm)	PCS	BARCODE
590134	0.45	340	103	30	36	6959820822375
590136	0.68	356	116	34	36	6959820822382
590139	0.91	381	126	37	24	6959820822399

**Claw Hammer Oak Wood Handle**

★ INTRODUCTION

- \* Forged fine grain steel head hardened.HRC>48
- \* Fully ground face and cheeks
- \* High quality oak wood handle

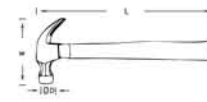

ITEM NO	SIZE(kg/oz)	L(mm)	W(mm)	ØD(mm)	PCS	BARCODE
590205	0.50/16	330	130	30	36	6959820821446

**Claw Hammer Tubular Handle**

★ INTRODUCTION

- \* Forged fine grain steel head hardened. HRC>48
- \* Fully ground face and cheeks
- \* Tubular steel shaft with comfortable rubber grip

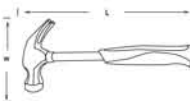

ITEM NO	SIZE(kg/oz)	L(mm)	W(mm)	ØD(mm)	PCS	BARCODE
590210	0.25/8	275	105	25	36	6959820821453
590211	0.50/16	315	125	30	36	6959820821460

**Claw Hammer Fiberglass Handle**

★ INTRODUCTION

- \* Forged fine grain steel head hardened.HRC>48
- \* Fully ground face and cheeks
- \* Two colors fiberglass shaft with comfortable ergonomics cushion grip.

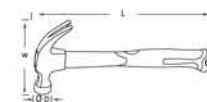

ITEM NO	SIZE(kg/oz)	L(mm)	W(mm)	ØD(mm)	PCS	BARCODE
590215	0.5/16	330	135	30	36	6959820821477

**Claw Hammer With Fiberglass Handle**

★ INTRODUCTION

- \* Forged fine grain steel head hardened.HRC>48
- \* Head with magnetic, easy for adsorption of nails while working.
- \* Two colors fiberglass shaft with comfortable ergonomics cushion grip.

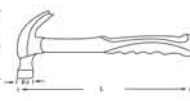

ITEM NO	SIZE(kg/oz)	L(mm)	W(mm)	ØD(mm)	PCS	BARCODE
590216	0.7/20	350	130	25	24	6959820822238

**Claw Hammer One Piece Forged**

★ INTRODUCTION

- \* Solid forged one piece, hardened and tempered.HRC>48
- \* Fully polished and lacquered.
- \* Solid forged shaft with shock-absorbing grip to reduce vibrations when striking.

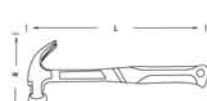

ITEM NO	SIZE(kg/oz)	L(mm)	W(mm)	ØD(mm)	PCS	BARCODE
590218	0.5/16	330	130	32	24	6959820821484

**Sledge Hammer Wood Handle**

★ INTRODUCTION

- \* Forged fine grain steel head hardened.HRC>48
- \* Fully ground face and cheeks
- \* High quality oak wood handle

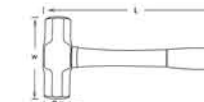

ITEM NO	SIZE(lb)	L(mm)	W(mm)	ØD(mm)	PCS	BARCODE
590303	3	350	112	46	12	6959820821491

**Installation Mallet**

★ INTRODUCTION

- \* PVC head
- \* Fiberglass handle

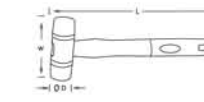

ITEM NO	SIZE(mm)	L(mm)	W(mm)	ØD(mm)	PCS	BARCODE
590402	30	290	92	30	60	6959820852358
590403	35	293	98	35	48	6959820852365

**White Rubber Mallet with Fibreglass Handle**

★ INTRODUCTION

- \* White rubber head,
- \* Two colors fiberglass shaft fitted ergonomics cushion grip, particularly useful for laying paving etc.

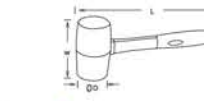

ITEM NO	SIZE(g)	L(mm)	W(mm)	ØD(mm)	PCS	BARCODE
590432	225	290	80	50	36	6959820853881
590435	500	335	95	63	24	6959820853898
590437	700	340	115	70	24	6959820853904

**Sledge Hammer Fiberglass Handle**

★ INTRODUCTION

- \* Forged fine grain steel head hardened.HRC>48
- \* Matt black painted head
- \* Two colors fiberglass shaft with comfortable ergonomics cushion grip



ITEM NO	SIZE(kg/lb)	L(mm)	W(mm)	ØD(mm)	PCS	BARCODE
590306	3/6	900	145	60	4	6959820821507
590308	4/8	900	165	60	4	695982082139
590310	5/10	900	180	64	2	695982082146
590312	6/12	900	190	68	2	695982082153
590314	7/14	900	198	72	2	695982082160
590316	8/16	900	208	75	2	695982082177

**Black Rubber Mallet With Fiberglass**

★ INTRODUCTION

- \* Black rubber head,
- \* Two colors fiberglass shaft fitted ergonomics cushion grip, particularly useful for laying paving etc.

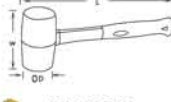

ITEM NO	SIZE(g)	L(mm)	W(mm)	ØD(mm)	PCS	BARCODE
590412	225	290	80	50	36	6959820854413
590415	500	334	95	57	24	6959820821545
590417	700	334	115	63	24	6959820821552

**Dead Blow Mallet Orange**

★ INTRODUCTION

- \* Ideal for heavy and effective blows
- \* The hollow head has steel particles which prevent rebound

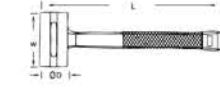

ITEM NO	SIZE(g)	L(mm)	W(mm)	ØD(mm)	PCS	BARCODE
590445	450	300	102	44	24	6959820821590
590449	900	340	102	52	24	6959820821606

**Brass Hammer With Fiberglass Handle**

★ INTRODUCTION

- \* Brass hammer head with soft surface
- \* No sparks while working
- \* Soft fiberglass handle for anti-skip



ITEM NO	SIZE(kg/lb)	L(mm)	W(mm)	ØD(mm)	PCS	BARCODE
590456	1/2	315	90	34	24	6959820821613

**1000G Splitting Maul With Fiberglass handle**

★ INTRODUCTION

- \*Forged Fine grain steel head
- \*Hardened and tempered
- \*Two colors fiberglass handle shaft with comfortable ergonomics cushion grip

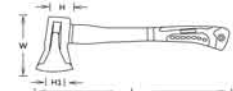

ITEM NO	SIZE	L(mm)	W(mm)	H(mm)	HI(mm)	PCS	BARCODE
590480	1000G	430	146	26	83	12	6959820851559

**Chipping Hammer**

★ INTRODUCTION

- \* Chipping Hammer
- \* Forged fine steel
- \* For rust cleaning in pipeline surface

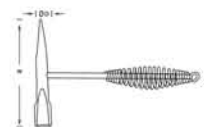

ITEM NO	SIZE	L(mm)	W(mm)	ØD(mm)	PCS	BARCODE
590541	500g	260	160	23	36	6959820821620

**7Pcs Auto Repair Tools Set**

★ INTRODUCTION

- \* Ideal for repairing car roof and body
- \* Forged fine grain medium carbon steel head correctly hardened, tempered, 3pcs hammers with two colors fiberglass handle, 4pcs blocks



ITEM NO	PCS	BARCODE
590527	2	6959820845534

**Axe With Fiberglass Handle**

★ INTRODUCTION

- \* Forged fine grain steel head hardened and tempered
- \* Ground edges finish and edge cover
- \* Two colors fiberglass handle shaft with comfortable ergonomics cushion grip.

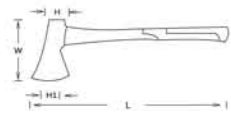

ITEM NO	SIZE(kg)	L(mm)	W(mm)	H(mm)	HI(mm)	PCS	BARCODE
590466	0.6	390	140	40	105	24	6959820822191
590468	0.8	390	163	47	105	24	6959820822207
590470	1.0	470	174	47	110	12	6959820822214
590475	1.5	910	192	64	124	6	6959820822221

**Splitting Maul With Fiberglass handle**

★ INTRODUCTION

- \*Forged Fine grain steel head
- \*Hardened and tempered
- \*Two colors fiberglass handle shaft with comfortable ergonomics cushion grip
- \*90cm length handle

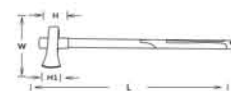

ITEM NO	SIZE	L(mm)	W(mm)	H(mm)	HI(mm)	PCS	BARCODE
590486	6LB	900mm	210	46	87	4	6959820851542
590488	8LB	900mm	215	52	87	4	6959820851924

**Fire Axe with Fiberglass Handle**

★ INTRODUCTION

- \* Forged fine grain steel head hardened and tempered.
- \* Ground edges finish and edge cover.
- \* Two colors fiberglass handle shaft with comfortable ergonomics cushion grip.

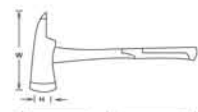

ITEM NO	SIZE(kg/mm)	L(mm)	W(mm)	H(mm)	PCS	BARCODE
590483	1.6/900	900	192	124	6	6959820847248

**Pick & Finishing Hammer**

★ INTRODUCTION

- \* Pick & Finishing Hammer
- \* Forged fine grain steel head hardened
- \* Natural straight grained hickory handle

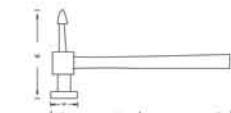

ITEM NO	L(mm)	W(mm)	H(mm)	PCS	BARCODE
590521	318	145	39	36	6959820845497

**Standard Bumping Hammer**

★ INTRODUCTION

- \* Forged fine grain steel head hardened
- \* Natural straight grained hickory handle

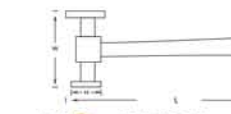

ITEM NO	L(mm)	W(mm)	H(mm)	PCS	BARCODE
590525	335	103	39	36	6959820845527

**400G Mini Pick Mattock With Fiberglass Handle**

★ INTRODUCTION

- \*Forged Fine grain steel head
- \*Hardened and tempered
- \*Two colors fiberglass handle shaft with comfortable ergonomics cushion grip
- \*38cm length handle

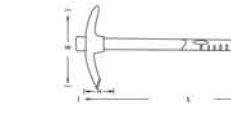

ITEM NO	SIZE	L(mm)	H(mm)	W(mm)	PCS	BARCODE
590604	400G	385	40	252	24	6959820851528

**1500G Pick Mattock With Fiberglass Handle**

★ INTRODUCTION

- \*Forged Fine grain steel head
- \*Hardened and tempered
- \*Two colors fiberglass handle shaft with comfortable ergonomics cushion grip
- \*90cm length handle

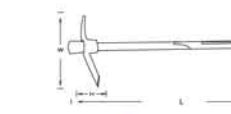

ITEM NO	SIZE	L(mm)	H(mm)	W(mm)	PCS	BARCODE
590615	1500G	900	55	460	6	6959820851511

**Straight Pein & Finishing Hammer**

★ INTRODUCTION

- \* Straight Pein & Finishing Hammer
- \* Forged fine grain steel head hardened
- \* Natural straight grained hickory handle

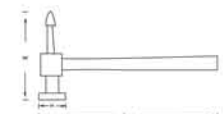

ITEM NO	L(mm)	W(mm)	H(mm)	PCS	BARCODE
590522	318	140	39	36	6959820845503

**Curved Pein & Finishing Hammer**

★ INTRODUCTION

- \* Forged fine grain steel head hardened
- \* Natural straight grained hickory handle



ITEM NO	L(mm)	W(mm)	H(mm)	PCS	BARCODE
590523	318	140	39	36	6959820845510

**400G Mini Cutter Mattock With Fiberglass Handle**

★ INTRODUCTION

- \*Forged Fine grain steel head
- \*Hardened and tempered
- \*Two colors fiberglass handle shaft with comfortable ergonomics cushion grip
- \*38cm length handle

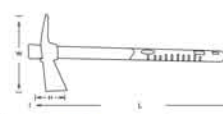

ITEM NO	SIZE	L(mm)	H(mm)	W(mm)	PCS	BARCODE
590614	400G	385	36	225	24	6959820851535

**600G Roffing Hammer with Fiberglass Handle**

★ INTRODUCTION

- \*Forged fine grain steel head hardened.HRC>48
- \*Matt black powder painted head
- \*Two colors fiberglass shaft with comfortable ergonomics cushion grip.

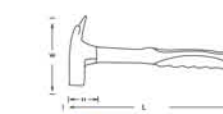

ITEM NO	SIZE	L(mm)	H(mm)	W(mm)	PCS	BARCODE
590660	600G	335	165	28	24	6959820853874

## G Clamp

### ★ INTRODUCTION

HT-250  

- \* Made from high grade iron casting
- \* For a wide variety of metalworking and woodworking applications
- \* The spindle has acme threads for a smooth operation and maximum clamping pressure

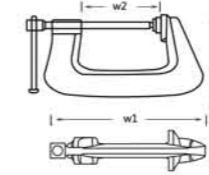

ITEM NO	SIZE	L(mm)	H(mm)	W1(mm)	W2(mm)	PCS	BARCODE
600200	2"	60	20	110	60	72	6959820835337
600201	3"	90	22	165	90	36	6959820825062
600202	4"	105	25	200	115	36	6959820825079
600203	6"	130	30	270	170	24	6959820825086
600204	8"	150	30	330	220	12	6959820825093
600205	10"	160	34	370	260	10	6959820825109

## Quick Ratchet Bar Clamp

### ★ INTRODUCTION

NYLON  

- \*Nylon-fiberglass mixture body
- \*Black finished bar
- \*Soft non-marking pads
- \* Packed by hang card

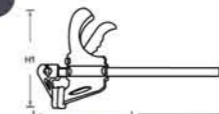

ITEM NO	SIZE	OPENING	L(mm)	H1(mm)	H2(mm)	PCS	BARCODE
600324	4"	100mm	195	110	3X8	120	6959820851566
600326	6"	150mm	330	210	5.5X18	36	6959820851573
600328	8"	200mm	380	210	5.5X18	36	6959820851580
600332	12"	300mm	480	210	5.5X18	24	6959820851597
600334	24"	600mm	775	210	5.5X18	24	6959820851603

## Two Jaw Gear Puller

### ★ INTRODUCTION

CS-45  

- \* Forged by Medium Carbon Steel
- \* Chrome plated surface with jaws

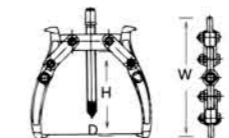

ITEM NO	SIZE	D(mm)	W(mm)	H(mm)	PCS	BARCODE
600411	3"	75	70	102	20	6959820825253
600412	4"	100	86	132	20	6959820825260
600413	6"	150	110	155	16	6959820825277
600415	8"	200	150	205	6	6959820825284

## Heavy Duty F Clamp

### ★ INTRODUCTION

HT-450-10  

- \* Nickel plated bar
- \* Black finished thread bar
- \* Two-component plastic handle

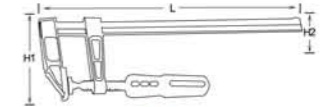

ITEM NO	SIZE	L(mm)	H1(mm)	H2(mm)	PCS	BARCODE
600301	50X150	150	50	5X15	50	6959820850699
600302	50X250	250	50	5X15	50	6959820850705
600303	80X300	300	80	6X22	30	6959820850712
600305	80X300	300	80	6X22	10	6959820850729
600306	120X600	600	120	8X30	10	6959820850736
600308	120X800	800	120	8X30	10	6959820850743
600309	120X1000	1000	120	8X30	8	6959820850750

## 6Pcs Spring Clamp Set

### ★ INTRODUCTION

NYLON  

- \*Nylon-fiberglass mixture body
- \*PE jaws
- \*Packed by hang bag

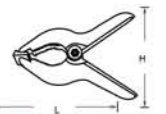

ITEM NO	SIZE	OPENING	L(mm)	H(mm)	PCS	BARCODE
600354	4"/6pcs	45mm	100	190	36	6959820851610
600356	6"/6pcs	65mm	150	115	36	6959820851627

## Three Jaw Gear Puller

### ★ INTRODUCTION

CS-45  

- \* Forged by Medium Carbon Steel
- \* Chrome plated surface with jaws

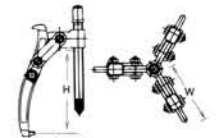

ITEM NO	SIZE	D(mm)	W(mm)	H(mm)	PCS	BARCODE
600421	3"	75	40	105	20	6959820825291
600422	4"	100	50	145	20	6959820825307
600423	6"	150	60	200	16	6959820825314
600425	8"	200	85	295	6	6959820825321

**50mm Mini Bench Vice**

★ INTRODUCTION

- \*Made from cast steel
- \*Clamp width: 50mm
- \*Clamp length: 32mm
- \*Packed by color box

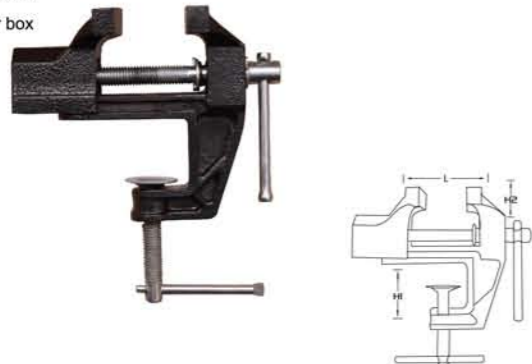

ITEM NO	SIZE	WEIGHT(KG)	L(mm)	H(mm)	H2(mm)	PCS	BARCODE
600601	50mm	0.7kg	32	30	50	30	6959820851306

**Heavy Duty Pipe Wrench**

★ INTRODUCTION

- \* Ductile iron handle
- \* CRV Jaw teeth induction quenched
- \* Surface can be painted different color



ITEM NO	SIZE	L(mm)	W1(mm)	W2(mm)	H(mm)	PCS	BARCODE
600812	12"	300±3.5%	57	40	19	36	6959820825727
600813	14"	350±3.5%	64	50	21	24	6959820825734
600814	18"	450±3.5%	75	60	24	12	6959820825741
600815	24"	600±5%	85	75	29	8	6959820825758
600816	36"	900±5%	115	85	30	4	6959820825765
600817	48"	1200±5%	136	110	33	2	6959820825772

**9Pcs Pipe Threading Set**

★ INTRODUCTION

- \* 6Pc Die head: 1/4", 3/8", 1/2", 3/4", 1", 1-1/4"
- \* 1Pc Aluminum ratcheting handle \* 2Pc extension bars



ITEM NO	SIZE	PCS	BARCODE
600871	1/4", 3/8", 1/2", 3/4", 1", 1-1/4"	4	6959820850767

**Heavy Duty Table Vice**

★ INTRODUCTION

- \* Made from cast iron
- \* 3" weight 6kg 4" weight 9kg
- \* 5" weight 10.5kg 6" weight 26.5kg
- \* 8" weight 36.5kg



ITEM NO	SIZE	OPEN L(mm)	W(mm)	H(mm)	PCS	BARCODE
600608	3"	260	75	135	1	6959820852341
600609	4"	310	100	160	1	6959820852334
600610	5"	335	125	170	1	6959820848559
600612	6"	470	150	220	1	6959820848566
600613	8"	540	200	235	1	6959820848573

**Desk Vice**

★ INTRODUCTION

- \* Table bench vices
- \* Forged cast iron
- \* Alloy steel teeth

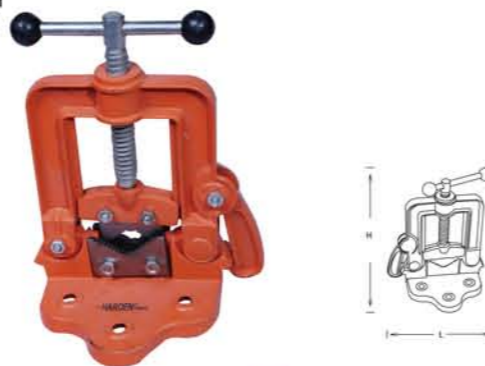

ITEM NO	SIZE	L(mm)	H(mm)	PCS	BARCODE
600892	2#	175	265	1	6959820825680
600894	4#	255	350	1	6959820825697

**Mini Pipe Cutter**

★ INTRODUCTION

- \* Cutting Dia.3-22mm
- \* Aluminum Alloy Body
- \* HSS blade



ITEM NO	SIZE	L1(mm)	L2(mm)	W1(mm)	W2(mm)	PCS	BARCODE
600821	3-22	55	24	38	35	96	6959820825499

**Pipe Cutter**

★ INTRODUCTION

- \* Cutting Dia.3-32mm
- \* Aluminum Alloy Body
- \* HSS blade



ITEM NO	SIZE	L1(mm)	L2(mm)	W1(mm)	W2(mm)	PCS	BARCODE
600822	3-22	135	30.5	56.5	35	72	6959820825505

**Heavy Duty Pipe Cutter**

★ INTRODUCTION

- \* Main body is Alloy Aluminum and Mn blade
- \* Suitable for cutting cooper tube, aluminum tube and thin-walled conduit



ITEM NO	SIZE	L(mm)	W(mm)	PCS	BARCODE
600825	12-50	385	105	8	6959820825529
600826	25-75	490	150	6	6959820825536

**PVC Pipe Cutter**

★ INTRODUCTION

- \* Main body is Alloy Aluminum and SK5 blade
- \* Scope :3-42mm
- \* Suitable for cutting the water pipe, aluminum plastic pipe, gas pipe, and electrical appliance pipe etc.



ITEM NO	SIZE(mm)	L(mm)	H(mm)	ØD(mm)	PCS	BARCODE
600851	42	190	90	48	50	6959820825567

**Pro PVC Pipe Cutter**

★ INTRODUCTION

- \* Main body is Alloy Aluminum and SK5 blade
- \* Scope :63mm
- \* Suitable for cutting the water pipe, aluminum plastic pipe, gas pipe, and electrical appliance pipe etc.



ITEM NO	SIZE(mm)	L(mm)	H(mm)	ØD(mm)	PCS	BARCODE
600854	63	301	140	63	40	6959820826250

**Pipe Cutter**

★ INTRODUCTION

- \* Cutting Dia.3-32mm
- \* Aluminum Alloy Body
- \* HSS blade



ITEM NO	SIZE	L1(mm)	L2(mm)	W1(mm)	W2(mm)	PCS	BARCODE
600823	6-64	220	72	95	44	24	6959820825512

**PVC Pipe Cutter**

★ INTRODUCTION

- \* Main body is Alloy Aluminum and SK5 blade
- \* Scope :36mm
- \* Suitable for cutting plastic pipe



ITEM NO	SIZE(mm)	L(mm)	H(mm)	ØD(mm)	PCS	BARCODE
600850	36	207	37	37	100	6959820826236

**Pro PVC Pipe Cutter**

★ INTRODUCTION

- \* Main body is Alloy Aluminum and SK5 blade
- \* Scope :42mm
- \* Suitable for cutting the water pipe, aluminum plastic pipe, gas pipe, and electrical appliance pipe etc.



ITEM NO	SIZE(mm)	L(mm)	H(mm)	ØD(mm)	PCS	BARCODE
600853	42	225	101	42	50	6959820826243

**Plastic Pipe Hand Saw**

★ INTRODUCTION

- \* Made of #1065 Mn steel, heat treated
- \* Saw teeth hardness >Hrc53, hardened and sharp
- \* Two sides grinding tooth, sharp and quickly remove the chip
- \* Plastic handle



ITEM NO	SIZE	L1(mm)	L2(mm)	L3(mm)	W(mm)	PCS	BARCODE
600860	14"	415	285	350	35	24	6959820847309

# TRIMMING TOOLS



## 10" Hand Riveter

### ★ INTRODUCTION



- \*Suitable for single handed application and made from steel
- \*PVC grip
- \*Provides a rigid permanent fixing and suitable for use with 2.4,3.2,4.0,4.8mm rivets

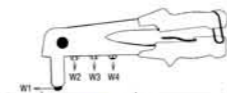

ITEM NO	SIZE	L mm	W1 mm	W2 mm	W3 mm	W4 mm	PCS	BARCODE
610102	10"	240	2.4	3.2	4.0	4.8	40	6959820851344

## Riveting Plier Set

### ★ INTRODUCTION



- \* Suitable for single handed application and made from quality steel with comfortable handles
- \* Provides a rigid permanent fixing and suitable for use with 2.4,3.2,4.0,4.8mm rivets

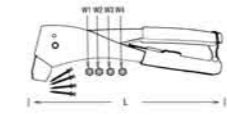

ITEM NO	SIZE	L mm	W1 mm	W2 mm	W3 mm	W4 mm	PCS	BARCODE
610104	10.5"	250	2.4	3.2	4.0	4.8	24	6959820831230

## 32" Folding Riveting Gun

### ★ INTRODUCTION



- \*Cr-Mo alloy steel clamp units
- \*Supplied complete five interchangeable nozzles for all popular rivet sizes
- \*For use with 3.2,4.0,4.8,6.0,6.4mm size rivets

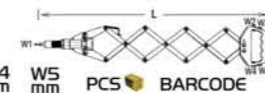

ITEM NO	SIZE	L mm	W1 mm	W2 mm	W3 mm	W4 mm	W5 mm	PCS	BARCODE
610114	32"	810	3.2	4.0	4.8	6.0	6.4	12	6959820590996

## Hand Riveter

### ★ INTRODUCTION



- \* Suitable for single handed application and made from quality steel with comfortable handles
- \* Provides a rigid permanent fixing and suitable for use with 2.4,3.2,4.0,4.8mm rivets

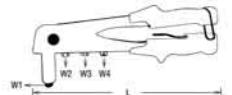

ITEM NO	SIZE	L mm	W1 mm	W2 mm	W3 mm	W4 mm	PCS	BARCODE
610106	10.5"	250	3.2	4.8	4.0	2.4	24	6959820831216

## Hand Riveter

### ★ INTRODUCTION



- \* Designed for deducing to a minimum the amount of effort required
- \* Supplied complete with interchangeable nozzles for 3.2,4.0,4.8mm rivets

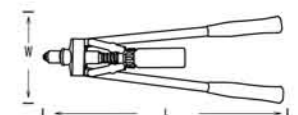

ITEM NO	SIZE	L(mm)	W1(mm)	PCS	BARCODE
610113	17"	410	115	20	6959820831223

## Hand Riveter

### ★ INTRODUCTION



- \* Designed for deducing to a minimum the amount of effort required
- \* Supplied complete with five interchangeable nozzles for all popular rivets sizes
- \* Provides a rigid permanent fixing and suitable for use with 2.4,3.2,4.0,4.8,6.4mm rivets

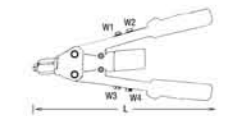

ITEM NO	SIZE	L mm	W1 mm	W2 mm	W3 mm	W4 mm	PCS	BARCODE
610115	13"	420	2.4	3.2	4.0	4.8	20	6959820848627

**Aluminum Rivet**

**★ INTRODUCTION**

- \* Made of aluminum alloy
- \* Matt chrome surface treatment
- \* Good toughness

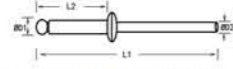

ITEM NO	SIZE(mm)	L1(mm)	L2(mm)	ØD1(mm)	ØD2(mm)	PCS	BARCODE
6I0I22	2.4x8	35	10	2.0	1.0	400	6959820847668
6I0I23	3.2x10	38	12	2.5	1.5	200	6959820847675
6I0I28	4x12.7	43	15	3.5	2.0	200	6959820847682
6I0I33	4.8x16	48	17	4.2	2.5	100	6959820847699

**HSS M2 Straight Shank Twist Drill For Metal**



ITEM NO	SIZE	L(mm)	H(mm)	PCS	BARCODE
6I0245	5.9mmx2pc	93	5.9	60	6959820830509
6I0246	6.0mmx2pc	93	6.0	60	6959820830516
6I0247	6.1mmx10pc	101	6.1	50	6959820830523
6I0248	6.2mmx10pc	101	6.2	50	6959820830530
6I0249	6.3mmx10pc	101	6.3	50	6959820830547
6I0250	6.4mmx10pc	101	6.4	50	6959820830554
6I0251	6.5mmx10pc	101	6.5	50	6959820830561
6I0252	6.6mmx10pc	101	6.6	50	6959820830578
6I0253	6.7mmx10pc	101	6.7	50	6959820830585
6I0254	6.8mmx10pc	109	6.8	50	6959820830592
6I0255	6.9mmx10pc	109	6.9	50	6959820830608
6I0256	7.0mmx10pc	109	7.0	50	6959820830615
6I0257	7.2mmx10pc	109	7.2	50	6959820830622
6I0258	7.5mmx10pc	109	7.5	50	6959820830639
6I0259	8.0mmx10pc	117	8.0	30	6959820830646
6I0260	8.5mmx5pc	117	8.5	30	6959820830653
6I0261	9.0mmx5pc	125	9.0	30	6959820830660
6I0262	9.5mmx5pc	125	9.5	30	6959820830677
6I0263	10.0mmx5pc	130	10.0	30	6959820830684
6I0264	10.2mmx5pc	133	10.2	30	6959820830691
6I0265	10.5mmx5pc	133	10.5	30	6959820830707
6I0266	11.0mmx5pc	142	11.0	30	6959820830714
6I0267	11.5mmx5pc	142	11.5	20	6959820830721
6I0268	12.0mmx5pc	151	12.0	20	6959820830738
6I0269	12.5mmx5pc	151	12.5	20	6959820830745
6I0270	13.0mmx5pc	151	13.0	20	6959820830752
6I0271	13.5mmx1pc	160	13.5	100	6959820830769
6I0272	14.0mmx1pc	160	14.0	100	6959820830776
6I0273	14.5mmx1pc	169	14.5	100	6959820830783
6I0274	15.0mmx1pc	170	15.0	100	6959820830790
6I0276	16.0mmx1pc	178	16.0	100	6959820830813
6I0278	17.0mmx1pc	184	17.0	90	6959820830837
6I0279	18.0mmx1pc	191	18.0	90	6959820830844
6I0281	19.0mmx1pc	198	19.0	20	6959820830868
6I0283	20.0mmx1pc	204	20.0	15	6959820830882

**HSS M2 Straight Shank Twist Drill For Metal**

**★ INTRODUCTION**

- \* Rolled form and treated body with heavy duty carbide tip
  - \* Use for percussion drilling in concrete, brick, stonework and cement
  - \* Unique tip design provides an efficient drilling action
- Optimised milled flute for fast drilling and special copper brazing to withstand high temperatures



ITEM NO	SIZE	L(mm)	H(mm)	PCS	BARCODE
6I0201	1.0mmx2pc	34	1.0	80	6959820830066
6I0202	1.5mmx2pc	40	1.5	80	6959820830073
6I0203	1.6mmx2pc	40	1.6	80	6959820830080
6I0204	1.7mmx2pc	40	1.7	80	6959820830097
6I0205	1.8mmx2pc	46	1.8	80	6959820830103
6I0206	2.0mmx2pc	46	2.0	80	6959820830110
6I0207	2.1mmx2pc	49	2.1	80	6959820830127
6I0208	2.2mmx2pc	53	2.2	80	6959820830134
6I0209	2.3mmx2pc	53	2.3	80	6959820830141
6I0210	2.4mmx2pc	57	2.4	80	6959820830158
6I0211	2.5mmx2pc	57	2.5	80	6959820830165
6I0212	2.6mmx2pc	57	2.6	80	6959820830172
6I0213	2.7mmx2pc	57	2.7	80	6959820830189
6I0214	2.8mmx2pc	61	2.8	80	6959820830196
6I0215	2.9mmx2pc	61	2.9	80	6959820830202
6I0216	3.0mmx2pc	61	3.0	80	6959820830209
6I0217	3.1mmx2pc	65	3.1	80	6959820830226
6I0219	3.3mmx2pc	65	3.3	80	6959820830240
6I0220	3.4mmx2pc	65	3.4	80	6959820830257
6I0221	3.5mmx2pc	70	3.5	80	6959820830264
6I0222	3.6mmx2pc	70	3.6	60	6959820830271
6I0223	3.7mmx2pc	70	3.7	60	6959820830288
6I0224	3.8mmx2pc	75	3.8	60	6959820830295
6I0225	3.9mmx2pc	75	3.9	60	6959820830301
6I0226	4.0mmx2pc	75	4.0	60	6959820830318
6I0227	4.1mmx2pc	75	4.1	60	6959820830325
6I0228	4.2mmx2pc	75	4.2	60	6959820830332
6I0229	4.3mmx2pc	80	4.3	60	6959820830349
6I0230	4.4mmx2pc	80	4.4	60	6959820830356
6I0231	4.5mmx2pc	80	4.5	60	6959820830363
6I0232	4.6mmx2pc	80	4.6	60	6959820830370
6I0233	4.7mmx2pc	80	4.7	60	6959820830387
6I0234	4.8mmx2pc	80	4.8	60	6959820830394
6I0235	4.9mmx2pc	86	4.9	60	6959820830400
6I0236	5.0mmx2pc	86	5.0	60	6959820830417
6I0237	5.1mmx2pc	86	5.1	60	6959820830424
6I0238	5.2mmx2pc	86	5.2	60	6959820830431
6I0239	5.3mmx2pc	86	5.3	60	6959820830448
6I0240	5.4mmx2pc	93	5.4	60	6959820830455
6I0241	5.5mmx2pc	93	5.5	60	6959820830462
6I0242	5.6mmx2pc	93	5.6	60	6959820830479
6I0243	5.7mmx2pc	93	5.7	60	6959820830486
6I0244	5.8mmx2pc	93	5.8	60	6959820830493

**5Pcs Masonry Drill Set**

**★ INTRODUCTION**

- \*Size: 4X75,5X85,6X100,8X120,10X120mm
- \*Carbide tip 130° general angle
- \*Cylindrical shank
- \*For use in brick masonry block light concrete



ITEM NO	SIZE	PCS	BARCODE
6I0285	5pcs	80	6959820852709

**16Pcs Drill Set**

**★ INTRODUCTION**

- \*Contains:
- 6pcs HSS TWIST drills: 2.0, 3.0, 4.0, 5.0, 6.0, 8.0mm
- 5pcs wood drills: 4.0, 5.0, 6.0, 8.0, 10.0 mm
- 6pcs masonry drills: 4.0, 5.0, 6.0, 8.0, 10.0 mm



ITEM NO	SIZE	PCS	BARCODE
6I0289	16pcs	24	6959820852723

**19Pcs Twist Drill Set**

**★ INTRODUCTION**

- \*Made from HSS steel
- Sizes: 1, 1.5, 2, 2.5, 3, 3.5, 4, 4.5, 5, 5.5, 6, 6.5, 7, 7.5, 8, 8.5, 9, 9.5, 10mm
- \*118° General angle



ITEM NO	SIZE	PCS	BARCODE
6I0292	19pcs	24	6959820852747

**8Pcs Wood Drill Set**

**★ INTRODUCTION**

- \*Size: 3, 4, 5, 6, 7, 8, 9, 10mm
- \*Made from carbon steel
- \*Hardened and tempered
- \*Black finished with polished surface



ITEM NO	SIZE	PCS	BARCODE
6I0287	8pcs	60	6959820852716

**13Pcs Twist Drill Set**

**★ INTRODUCTION**

- \*Made from HSS steel
- Sizes: 1.5, 2, 2.5, 3, 3.2, 3.5, 4, 4.5, 4.8, 5, 5.5, 6, 6.5mm
- \*118° General angle



ITEM NO	SIZE	PCS	BARCODE
6I0291	13pcs	48	6959820852730

**25Pcs Twist Drill Set**

**★ INTRODUCTION**

- \*Made from HSS steel
- Sizes: 1, 1.5, 2, 2.5, 3, 3.5, 4, 4.5, 5, 5.5, 6, 6.5, 7, 7.5, 8, 8.5, 9, 9.5, 10, 10.5, 11, 11.5, 12, 12.5, 13mm
- \*118° General angle



ITEM NO	SIZE	PCS	BARCODE
6I0293	25pcs	10	6959820852754

**SDS-Plus Round Shank Electric Hammer Drill Bits**

★ INTRODUCTION



- \* Fast drilling professional bit for SDS or Max systems
- \* Multi Cutter design (5/8" and above) for faster drilling, longer life and rounder holes
- \* Double narrow land flute design for faster dust extraction, less vibration, less friction and more impact energy to the tip.
- \* Tool shaft is heat treated, annealed and shot peened for longer life.
- \* Premium grade hammer carbide for use with heavy duty hammers



**BRICK WALL DRILLING**



**TILE DRILLING**



**CONCRETE DRILLING**



**STONEWALL DRILLING**



ITEM NO	SIZE(mm)	L(mm)	H(mm)	PCS	BARCODE
610301	6x110	110	6	400	6959820831599
610302	6x160	160	6	300	6959820831605
610307	8x110	110	8	250	6959820831643
610308	8x160	160	8	250	6959820831650
610312	10x160	160	10	200	6959820831681
610314	10x300	300	10	100	6959820831704
610316	12x160	160	12	250	6959820831711
610318	12x350	350	12	100	6959820831735
610320	14x160	160	14	300	6959820831742
610322	14x350	350	14	100	6959820831766
610323	16x160	160	16	100	6959820831773
610325	16x350	350	16	50	6959820831797
610328	18x350	350	18	50	6959820831810
610331	20x350	350	20	30	6959820831834
610334	22x350	350	22	30	6959820831858
610337	25x350	350	25	30	6959820831872
610339	28x350	350	28	20	6959820831889
610341	30x350	350	30	20	6959820831896
610343	32x350	350	32	10	6959820831902
610345	35x350	350	35	10	6959820831919

**SDS-Plus Point Chisel**

★ INTRODUCTION



- \* Fits hammer drills with SDS-Plus chucking and 2-slot chucking system
- \* Machined from chrome steel fitted with carbide insert brazed at a very high temperature(1120 °C ) to with stand severe heating when drilling hard materials



ITEM NO	SIZE(mm)	L(mm)	H(mm)	PCS	BARCODE
610392	14x250	250	0	50	6959820849969

**SDS-Plus Flat Chisel**

★ INTRODUCTION



- \* Fits hammer drills with SDS-Plus chucking and 2-slot chucking system
- \* Machined from chrome steel fitted with carbide insert brazed at a very high temperature(1120 °C ) to with stand severe heating when drilling hard materials



ITEM NO	SIZE(mm)	L(mm)	H(mm)	PCS	BARCODE
610393	14x250X20	250	20	50	6959820849976

**SDS-Plus Flat Chisel**

★ INTRODUCTION



- \* Fits hammer drills with SDS-Plus chucking and 2-slot chucking system
- \* Machined from chrome steel fitted with carbide insert brazed at a very high temperature(1120 °C ) to with stand severe heating when drilling hard materials



ITEM NO	SIZE(mm)	L(mm)	H(mm)	PCS	BARCODE
610394	14x250x50	250	50	50	6959820849983

**SDS-Plus U Type Chisel**

★ INTRODUCTION



- \* Fits hammer drills with SDS-Plus chucking and 2-slot chucking system
- \* Machined from chrome steel fitted with carbide insert brazed at a very high temperature(1120 °C ) to with stand severe heating when drilling hard materials

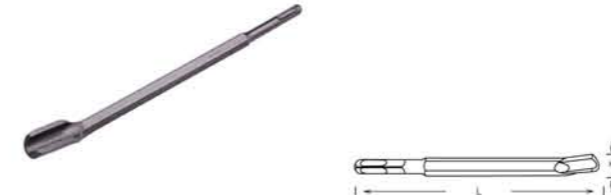

ITEM NO	SIZE(mm)	L(mm)	H(mm)	PCS	BARCODE
610395	14x250x22	250	22	50	6959820849990

**17X280X25mm Hex Flat Chisel**

★ INTRODUCTION



- \* Chrome alloy steel, heat treated and tempered
- \* HRC>50
- \* Santi finishing
- \* Cooperate with use HAEDA #750811 #750812



ITEM NO	SIZE	L(mm)	H(mm)	PCS	BARCODE
610397	17X280X25mm	280mm	17mm	50	6959820851955

**30X410X25mm Hex Flat Chisel**

★ INTRODUCTION



- \* Chrome alloy steel, heat treated and tempered
- \* HRC>50
- \* Santi finishing
- \* Cooperate with use HAEDA #750831 #750832



ITEM NO	SIZE	L(mm)	H(mm)	PCS	BARCODE
610399	30X410X25mm	410mm	30mm	10	6959820851979

**17X280mm Hex Point Chisel**

★ INTRODUCTION



- \* Chrome alloy steel, heat treated and tempered
- \* HRC>50
- \* Santi finishing
- \* Cooperate with use HAEDA #750811 #750812



ITEM NO	SIZE	L(mm)	H(mm)	PCS	BARCODE
610396	17X280mm	280mm	17mm	50	6959820851948

**30X410mm Hex Point Chisel**

★ INTRODUCTION



- \* Chrome alloy steel, heat treated and tempered
- \* HRC>50
- \* Santi finishing
- \* Cooperate with use HAEDA #750831 #750832



ITEM NO	SIZE	L(mm)	H(mm)	PCS	BARCODE
610398	30X410mm	410mm	30mm	10	6959820851962

**Metric Tap For Machinery**

★ INTRODUCTION



- \* Manufactured from quality M35 High Speed Steel
- \* Suitable for cleaning and cutting threads in mild steel, aluminium and brass



ITEM NO	SIZE	L(mm)	W1(mm)	W2(mm)	PCS	BARCODE
610411	M3x10PCS	48	3.15	3	400	6959820830974
610412	M4x10PCS	53	4.0	4	400	6959820830981
610413	M5x10PCS	58	5.0	5	200	6959820830998
610414	M6x10PCS	66	6.3	6	200	6959820831001
610416	M8x10PCS	72	6.3	8	140	6959820831018
610417	M10x5PCS	85	8.0	11	140	6959820831025
610418	M12x5PCS	89	9.0	12	140	6959820831032
610419	M14x1PCS	95	11.2	14	480	6959820831049
610420	M16x1PCS	102	12.5	16	480	6959820831056
610421	M18x1PCS	112	14.0	18	300	6959820831100
610422	M20x1PCS	112	14.0	20	300	6959820831117
610423	M22x1PCS	118	6.0	22	200	6959820831124
610424	M24x1PCS	130	6.0	24	200	6959820831131

**Tap Holder**

★ **INTRODUCTION**



- \* Industrial quality bar type tap wrenches manufactured from a high quality steel
- \* Black powder coated and houses two steel jaws
- \* Providing greater leverage

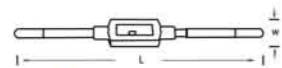

ITEM NO	SIZE	L(mm)	W(mm)	PCS	BARCODE
610431	M3-I2	200	23.4	192	6959820831186

**Die Holder**

★ **INTRODUCTION**



- \* Used for holding rod dies when clean cutting external threads
- \* The body and ends are black power coated with each end knurled for a comfortable non-slip grip

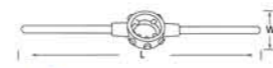

ITEM NO	SIZE(mm)	L(mm)	W(mm)	PCS	BARCODE
610433	25x9	220	32	192	6959820831193

**32Pcs Screw Tap**

★ **INTRODUCTION**



- \* Manufactured from high quality alloy steel,
- \* Suitable for cleaning and cutting threads in Mild Steel, Aluminium and Brass The set include the following:
- \* 21Pcs metric tap
- \* 7Pcs Metric Die
- \* 1Pc Tap Holder
- \* 1Pc Die Holde
- \* 1Pc Screwdriver
- \* 1Pc Screw-pitch Gauge



ITEM NO	SIZE	PCS	BARCODE
610453	32pcs	10	6959820831209

**12Pcs Tap and Die Set**

★ **INTRODUCTION**



- \* Manufactured from high quality alloy steel,
- \* Suitable for cleaning and cutting threads in Mild steel, Aluminium and Brass The set include the following:
- \* 5Pcs metric tap 6x1.0, 7x1.0, 8x1.25, 10x1.5, 12x1.75
- \* 5Pcs Metric Die Size same as Tap
- \* 1Pc Tap Holder
- \* 1Pc Die Holder



ITEM NO	SIZE	PCS	BARCODE
610457	12pcs	24	6959820832251

**20Pcs Tap and Die Set**

★ **INTRODUCTION**



- \* Manufactured from high quality alloy steel,
- \* Suitable for cleaning and cutting threads in Mild Steel, Aluminium and Brass The set include the following:
- \* 9Pcs metric tap 3x0.5, 4x0.7, 5x0.8, 6x1.0, 7x1.8x1.25, 9x1.25, 10x1.5, 12x1.75
- \* 9Pcs Metric Die Size same as Tap
- \* 1Pc Tap Holder
- \* 1Pc Die Holder



ITEM NO	SIZE	PCS	BARCODE
610458	20pcs	24	6959820832268

**40Pcs Tap and Die Set**

★ **INTRODUCTION**



- \* Manufactured from high quality alloy steel,
- \* Suitable for cleaning and cutting threads in Mild Steel, Aluminium and Brass The set include the following:
- \* 16Pcs metric tap 3x0.5, 3x0.6, 4x0.7, 4x0.75, 5x0.8, 5x0.9, 6x1.0, 6x0.75, 7x0.75, 7x1.8x1.25, 8x1.0, 10x1.25, 10x1.5, 12x1.75, 12x1.5
- \* 16Pc Dies: same size as taps
- \* 1Pc T Type Tap Wrench(M3-M6)
- \* 1Pc Screw-pitch Gauge
- \* 1Pc Tap Holder
- \* 1Pc NPT Tap: 1/8-27
- \* 1Pc Die Holder(M25)
- \* 1Pc Screwdriver
- \* 1Pc Tap Wrench



ITEM NO	SIZE	PCS	BARCODE
610459	40pcs	10	6959820832275

**Bi-Metal Hole Saw For Metal**

★ **INTRODUCTION**



- \* Bi-metal holesaw are constructed of hardened, heat and abrasion resisting high speed teeth with a tough alloy body and cap
- \* Exceptional strength, durability and resistance for user safety
- \* Cut any wood, metal or plastic in either a hand-held drill or a drill press
- \* Max cutting depth 38mm



ITEM NO	SIZE(mm)	L(mm)	W(mm)	PCS	BARCODE
610501	16	16	43	60	6959820831247
610502	18	18	43	60	6959820831254
610503	19	19	43	60	6959820831261
610504	20	20	43	60	6959820831278
610505	21	21	43	60	6959820831285
610506	22	22	43	60	6959820831292
610507	25	25	43	60	6959820831308
610508	26	26	43	60	6959820831315
610509	28	28	43	60	6959820831322
610510	29	29	43	60	6959820831339
610511	30	30	43	60	6959820831346
610512	32	32	43	60	6959820831353
610513	35	35	43	60	6959820831360
610514	38	38	43	60	6959820831377
610515	40	40	43	60	6959820831384
610516	42	42	43	60	6959820831391
610517	44	44	43	60	6959820831407
610518	45	45	43	60	6959820831414
610519	51	51	43	60	6959820831421
610520	53	53	43	60	6959820831438
610521	54	54	43	60	6959820831445
610522	57	57	43	60	6959820831452
610523	59	59	43	60	6959820831469
610524	60	60	43	60	6959820831476
610525	64	64	43	60	6959820831483

**Hole Saw Arbor**

★ **INTRODUCTION**



- \* Fitted with a pilot drill with set screw in the arbor body allowing easy replacement of the pilot drill
- \* Available in multiple chuck sizes for toughness and long life

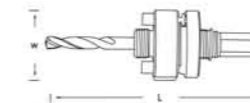

ITEM NO	SIZE(mm)	L(mm)	W(mm)	PCS	BARCODE
610530	14-30	128	20	80	6959820831490
610536	32-64	115	35	64	6959820831506

**3Pcs Holesaw Set For Wood**

★ **INTRODUCTION**



- \* High carbon steel, variable pitch tooth
- \* Teeth constructed from hardened heat with hardness HC46-53
- \* Can cut holes up to 25mm



ITEM NO	SIZE	PCS	BARCODE
610541	3PC	60	6959820831513

**8Pcs Hole Saw Kits For Wood**

★ **INTRODUCTION**



- \* High carbon steel, variable pitch tooth
- \* Teeth constructed from hardened heat with hardness HC46-53
- \* Can cut holes up to 25mm
- \* Kit containing one of each for the following: 2-1/2"(64mm), 3"(76mm), 3-1/2"(89mm), 4"(102mm), 5"(127mm)



ITEM NO	SIZE	PCS	BARCODE
610545	8PCS	20	6959820831520

**11Pcs Hole Saw Kits For Wood**

★ **INTRODUCTION**



- \* High carbon steel, variable pitch tooth
- \* Teeth constructed from hardened heat with hardness HC46-53
- \* Can cut holes up to 25mm
- \* Kit containing one of each for the following: 3/4"(19mm), 7/8"(22mm), 1-1/8"(29mm), 1-1/4"(32mm), 1-1/2"(38mm), 1-3/4"(44mm), 2"(51mm), 2-1/2"(64mm),



ITEM NO	SIZE	PCS	BARCODE
610546	11PCS	20	6959820831537



**16Pcs Hole Saw Kits For Wood**

★ INTRODUCTION



- \* High carbon steel, variable pitch tooth
- \* Teeth constructed from hardened heat with hardness HC46-53
- \* Can cut holes up to 25mm
- \* Kit containing one of each for the following: 3/4"(19mm), 7/8"(22mm), 1-1/8"(29mm), 1-1/4"(32mm), 1-1/2"(38mm), 1-3/4"(44mm), 2"(51mm), 2-1/2"(64mm), 3"(76mm), 3-1/2"(89mm), 4"(102mm), 5"(127mm)



ITEM NO	SIZE	PCS	BARCODE
610548	16PCS	20	6959820831544

**Pipe thread extractor**

★ INTRODUCTION



- \* Manufactured from chrome steel
- \* Recommended for simple, low cost removal of broken screws
- \* Without damaging the threads of the component



ITEM NO	SIZE	L1(mm)	H(mm)	W(mm)	PCS	BARCODE
610564	DN15/M25-M35	98	11	15	60	6959820850132
610566	DN20/M35-M50	104	13	19	60	6959820850149

**10Pcs Needle Files Set**

★ INTRODUCTION



- \* Used by engravers, precision engineers, instrument makers, watchmakers and goldsmith
- One of each of the following: hand, flat, half round, square, three square, round



ITEM NO	SIZE	PCS	BARCODE
610622	4x160mm	120	6959820825161

**5Pcs Coarse Thread Screw Extractor Set**

★ INTRODUCTION



- \* Manufactured from quality Cr-Mo steel
- \* Recommended for simple, low cost removal of broken screws
- \* Without damaging the threads of the component



ITEM NO	SIZE	PCS	BARCODE
610555	5PCS	100	6959820831551

**5Pcs Needle Files Set**

★ INTRODUCTION



- \* Used by engravers, precision engineers, instrument makers, and goldsmith
- One of each of the following: hand, half round, square, three square, round



ITEM NO	SIZE	PCS	BARCODE
610621	5x185mm	120	6959820825154

**Half Round Wood File**

★ INTRODUCTION



- \* Steel file for work in plywood, wallboard, plastic and other soft material
- \* The comfortable ergo handle gives good grip and control

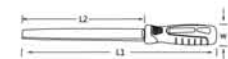

ITEM NO	SIZE	L1(mm)	L2(mm)	W(mm)	PCS	BARCODE
610618	8"	300	200	25	72	6959820850538

**5PCS Woodworking File**

★ INTRODUCTION



- \* 1pcs medium tooth file
- \* 1pcs medium tooth triangular file
- \* 1PCS medium tooth semicircular file
- \* 1PCS medium tooth half round file
- \* 1PCS carpentry semi-circular file
- \* file body hardness up to HRC62-65 degrees

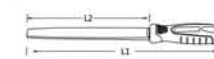

ITEM NO	SIZE	L1(mm)	L2(mm)	W(mm)	PCS	BARCODE
610631	8"	300	200	25	20	6959820850316

**Flat Second Cut File With Soft Handle**

★ INTRODUCTION



- \* Wood file for work in plywood, wallboard, plastic and other soft material
- \* The comfortable ergo handle gives good grip and control

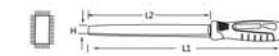

ITEM NO	SIZE	L1(mm)	L2(mm)	H(mm)	W(mm)	PCS	BARCODE
610636	6"	265	150	15.8±0.3	33.8	72	6959820825826
610637	8"	315	200	19.4±0.3	33.8	72	6959820825833
610638	10"	365	250	23.2±0.3	33.8	72	6959820825840
610639	12"	415	300	27.2±0.3	33.8	48	6959820825857

**Half Round Second Cut File With Soft Handle**

★ INTRODUCTION



- \* Wood file for work in plywood, wallboard, plastic and other soft material
- \* The comfortable ergo handle gives good grip and control

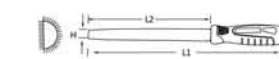

ITEM NO	SIZE	L1(mm)	L2(mm)	H(mm)	W(mm)	PCS	BARCODE
610656	6"	265	150	12.0±0.5	33.8	72	6959820825949
610657	8"	315	200	15.5±0.5	33.8	72	6959820825956
610658	10"	365	250	17.5±1.0	33.8	72	6959820825963
610659	12"	415	300	20.0±1.0	33.8	48	6959820825970

**Flat Bastard Mill File With Soft Handle**

★ INTRODUCTION



- \* Wood file for work in plywood, wallboard, plastic and other soft material
- \* The comfortable ergo handle gives good grip and control

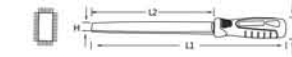

ITEM NO	SIZE	L1(mm)	L2(mm)	H(mm)	W(mm)	PCS	BARCODE
610632	6"	265	150	15.8±0.3	33.8	72	6959820825789
610633	8"	315	200	19.4±0.3	33.8	72	6959820825796
610634	10"	365	250	23.2±0.3	33.8	72	6959820825802
610635	12"	415	300	27.2±0.3	33.8	48	6959820825819

**Flat Smooth File With Soft Handle**

★ INTRODUCTION



- \* Wood file for work in plywood, wallboard, plastic and other soft material
- \* The comfortable ergo handle gives good grip and control

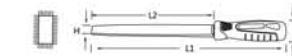

ITEM NO	SIZE	L1(mm)	L2(mm)	H(mm)	W(mm)	PCS	BARCODE
610642	6"	265	150	15.8±0.3	33.8	72	6959820825864
610643	8"	315	200	19.4±0.3	33.8	72	6959820825871
610644	10"	365	250	23.2±0.3	33.8	72	6959820825888
610645	12"	415	300	27.2±0.3	33.8	48	6959820825895

**Square Second Cut File With Soft Handle**

★ INTRODUCTION



- \* Wood file for work in plywood, wallboard, plastic and other soft material
- \* The comfortable ergo handle gives good grip and control

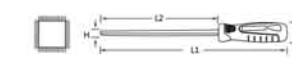

ITEM NO	SIZE	L1(mm)	L2(mm)	H(mm)	W(mm)	PCS	BARCODE
610676	6"	265	150	4.8±0.3	33.8	72	6959820826069
610677	8"	315	200	5.8±0.4	33.8	72	6959820826076
610678	10"	365	250	7.0±0.4	33.8	72	6959820826083
610679	12"	415	300	8.5±0.4	33.8	48	6959820826090

**Round Second Cut File With Soft Handle**

★ INTRODUCTION



- \* Wood file for work in plywood, wallboard, plastic and other soft material
- \* The comfortable ergo handle gives good grip and control



ITEM NO	SIZE	L1(mm)	L2(mm)	H(mm)	W(mm)	PCS	BARCODE
610692	6"	265	150	4.1±0.3	33.8	72	6959820826144
610693	8"	315	200	5.5±0.3	33.8	72	6959820826151
610694	10"	365	250	7.0±0.3	33.8	72	6959820826168
610695	12"	415	300	8.6±0.3	33.8	48	6959820826175

**Hacksaw Frame**

★ INTRODUCTION



- \* Hacksaw Frame
- \* The slim design improves access into confined spaces



ITEM NO	SIZE	L(mm)	W1(mm)	W2(mm)	PCS	BARCODE
610702	12"	420	130	145	48	6959820816732

**Hacksaw Frame Aluminium Handle**

★ INTRODUCTION



- \* Professional hacksaw frame features soft grip handles for extra comfort
- \* Easy blade changing system and a secondary blade position for flush cutting



ITEM NO	SIZE	L(mm)	W1(mm)	W2(mm)	PCS	BARCODE
610705	12"	405	132	164	24	6959820832824

**Mini Hacksaw Frame**

★ INTRODUCTION



- \* An epoxy coated steel frame, supplied with a hardened and tempered blade which is ideal for small cutting in metal and wood



ITEM NO	SIZE	L(mm)	W1(mm)	W2(mm)	PCS	BARCODE
610701	6"	250	65	95	120	6959820816725

**Adjustable Hacksaw Frame**

★ INTRODUCTION



- \* Adjustable Hacksaw Frame
- \* The whole steel construction frame ensures long life usage



ITEM NO	SIZE	L(mm)	W1(mm)	W2(mm)	PCS	BARCODE
610703	10"/12"	460	100	120	40	6959820816749

**6" 50Pcs High Carbon Steel Saw Blade**

★ INTRODUCTION



- \* Suitable to the application in cutting plastic, wood, pvc etc

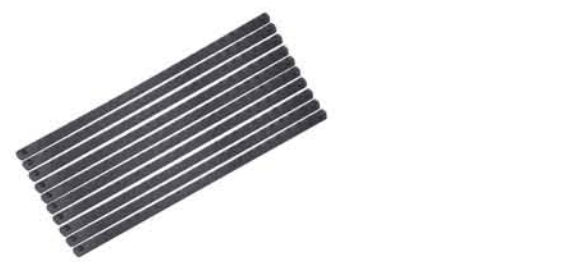

ITEM NO	SIZE	PCS	BARCODE
610711	6"	20	6959820851023

**12"X18 Tooth 10Pcs Bi-Metal Saw Blade**

★ INTRODUCTION



- \* Bi-Metal Saw Blade
- \* Suitable to the application in cutting stainless steel, alloy steel etc



ITEM NO	SIZE	PCS	BARCODE
610712	12"x18TEETH	100	6959820816763
610716	12"x24TEETH	100	6959820816770

**6Pcs Pin Punch Set**

★ INTRODUCTION



- \* 6Pcs Pin Punch Set
- \* Manufactured from Chrome Vanadium steel
- \* Used for punching out pins and dowels



ITEM NO	SIZE	PCS	BARCODE
610836	10"	24	6959820832626

**Point Chisel TPR Handle**

★ INTRODUCTION



- \* Manufactured from quality Chrome Vanadium tempered and heated
- \* Powder painted surface for rust resisting
- \* Suitable for the field of construction, decoration etc



ITEM NO	SIZE	L1(mm)	L2(mm)	W(mm)	H(mm)	PCS	BARCODE
610842	19x250	250	115	21.5	25	24	6959820821736

**12" 50Pcs High Carbon Steel Saw Blade 24 Tooth**

★ INTRODUCTION



- \* High Carbon Steel Saw Blade 24 Tooth
- \* Suitable to the application in cutting stainless steel, alloy steel etc

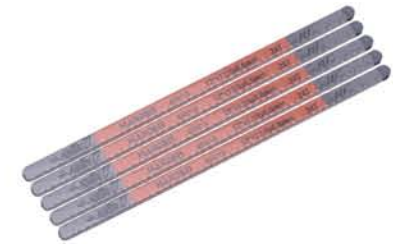

ITEM NO	SIZE	PCS	BARCODE
610719	12"	20	6959820816787

**Flat Chisel TPR Handle**

★ INTRODUCTION



- \* Manufactured from quality Chrome Vanadium tempered and heated
- \* Powder painted surface for rust resisting
- \* Suitable for the field of construction, decoration etc



ITEM NO	SIZE	L1(mm)	L2(mm)	W(mm)	H(mm)	PCS	BARCODE
610841	19x250	250	115	21.5	25	24	6959820821729

**12Pcs Hollow Punch Set**

★ INTRODUCTION



- \* Manufactured from Chrome Vanadium steel
- \* Used for punching out pins and dowels



ITEM NO	SIZE	PCS	BARCODE
610848	3-16mm	20	6959820821743

9Pcs Steel Number

★ INTRODUCTION

- \* Designed perfect for permanently marking metal or wood
- \* Manufactured from Chrome Vanadium tempered and heated with full sizes available



ITEM NO	SIZE(mm)	L(mm)	W(mm)	PCS	BARCODE
610853	3	63	6	100	6959820821750
610854	4	63	8	100	6959820821767
610855	5	63	8	100	6959820821774
610856	6	63	8	50	6959820821781
610858	8	67	12	30	6959820821798
610859	10	75	15	24	6959820821804

2Pcs Mini Edge Cutter

★ INTRODUCTION

- \* 2Pcs Mini Edge Cutter
- \* Suitable for the trimming on steel, brass, plastic and stainless steel
- \* 1Pc high speed steel blade included



ITEM NO	L1(mm)	L2(mm)	D(mm)	PCS	BARCODE
610901	141	22.5	8.3	96	6959820825017

2Pcs Edge Cutter

★ INTRODUCTION

- \* 2Pcs Edge Cutter
- \* Suitable for the trimming on steel, brass, plastic and stainless steel
- \* 1Pc high speed steel blade included



ITEM NO	L1(mm)	L2(mm)	D(mm)	PCS	BARCODE
610902	148	22.5	21.6	72	6959820825024

10Pcs Blades For Edge Cutter

★ INTRODUCTION

- \* 10Pcs Blades For Edge Cutter
- \* Manufactured from M2 high speed steel with sharpen blade



ITEM NO	L1(mm)	L2(mm)	W(mm)	D(mm)	PCS	BARCODE
610905	48	15	11	3.1	144	6959820825031

27Pcs Steel Letters

★ INTRODUCTION

- \* Designed perfect for permanently marking metal or wood
- \* Manufactured from Chrome Vanadium tempered and heated with full sizes available



ITEM NO	SIZE(mm)	L(mm)	W(mm)	PCS	BARCODE
610863	3	63	6	30	6959820821811
610864	4	63	8	30	6959820821828
610865	5	63	8	20	6959820821835
610866	6	63	8	20	6959820821842
610868	8	67	12	10	6959820821859
610869	10	75	15	8	6959820821866

3PCS Woodwork Chisel Set

★ INTRODUCTION

- \* High carbon steel blade
- \* Full surface machine grinding
- \* PP handle



ITEM NO	SIZE	L(mm)	PCS	BARCODE
611001	13mm,19mm,25mm	235-255	36	6959820848245

4PCS Woodwork Chisel Set

★ INTRODUCTION

- \* Chrome vanadium steel blade
- \* Full surface machine grinding
- \* Comfortable handle



ITEM NO	SIZE	L(mm)	PCS	BARCODE
611011	6mm,13mm,19mm,25mm	255-275	20	6959820848146

Comfortable Handle Wood Chisel

★ INTRODUCTION

- \* Chrome vanadium steel blade
- \* Full surface machine grinding
- \* Comfortable handle



ITEM NO	SIZE	L(mm)	W(mm)	PCS	BARCODE
611012	6mm	250	6	72	6959820848139
611013	10mm	250	10	72	6959820848122
611014	13mm	250	13	72	6959820848115
611015	16mm	250	16	72	6959820848108
611016	19mm	250	19	72	6959820848092
611017	22mm	275	22	72	6959820848085
611018	25mm	275	25	72	6959820848078
611019	32mm	275	32	72	6959820848061

Diamond Cutting Blade

★ INTRODUCTION

- \* Diamond saw blade, 65MN matrix base

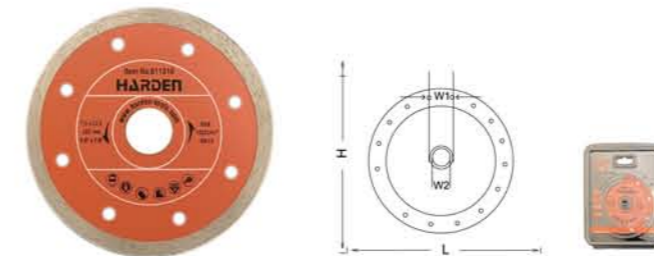

ITEM NO	SIZE	L mm	H mm	W1 mm	W2 mm	PCS	BARCODE
611308	100(4')X20	100	100	20	16	100	6959820849792
611310	115(4-1/2')X22.2	115	115	22.2	20	100	6959820848689
611312	125(5')X22.2	125	125	22.2	20	100	6959820848696
611314	180(7')X22.2	180	180	22.2	20	50	6959820848702
611316	230(9')X22.2	230	230	22.2	20	25	6959820848719

Diamond Cutting Blade

★ INTRODUCTION

- \* Diamond turbo grinding wheel, 65MN matrix base

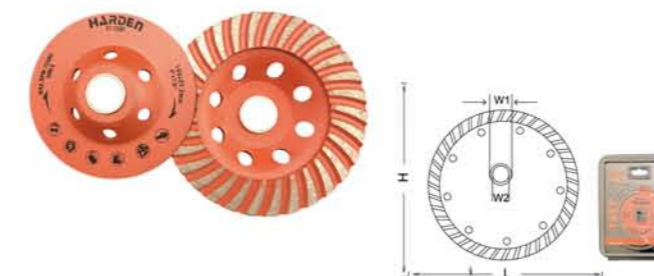

ITEM NO	SIZE	L mm	H mm	W1 mm	W2 mm	PCS	BARCODE
611330	100X22.2	100	110	22.2	20	20	6959820848764
611332	115X22.2	115	115	22.2	20	20	6959820848771
611334	125X22.2	125	125	22.2	20	20	6959820848788

Diamond Cutting Blade

★ INTRODUCTION

- \* Diamond saw blade, 65MN matrix base

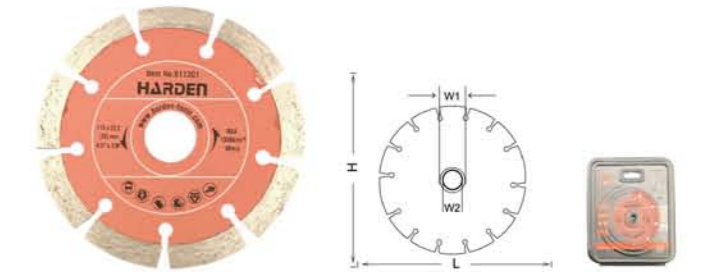

ITEM NO	SIZE	L mm	H mm	W1 mm	W2 mm	PCS	BARCODE
611300	100(4')X20	100	100	20	16	100	6959820849785
611301	115(4-1/2')X22.2	115	115	22.2	20	100	6959820848641
611302	125(5')X22.2	125	125	22.2	20	100	6959820848658
611304	180(7')X22.2	180	180	22.2	20	50	6959820848665
611306	230(9')X22.2	230	230	22.2	20	25	6959820848672

Diamond Cutting Blade

★ INTRODUCTION

- \* Diamond saw blade, 65MN matrix base

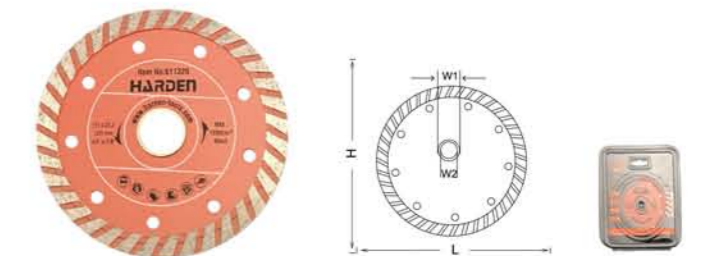

ITEM NO	SIZE	L mm	H mm	W1 mm	W2 mm	PCS	BARCODE
611318	100(4')X20	100	100	20	16	100	6959820849808
611320	115(4-1/2')X22.2	115	115	22.2	20	100	6959820848726
611322	125(5')X22.2	125	125	22.2	20	100	6959820848733
611324	180(7')X22.2	180	180	22.2	20	50	6959820848740
611326	230(9')X22.2	230	230	22.2	20	25	6959820848757

Cup Wire Brush With Nut

★ INTRODUCTION

- \* Ideal for removing rust, paint and varnish from metal surfaces
- \* Wire dia: 0.3mm

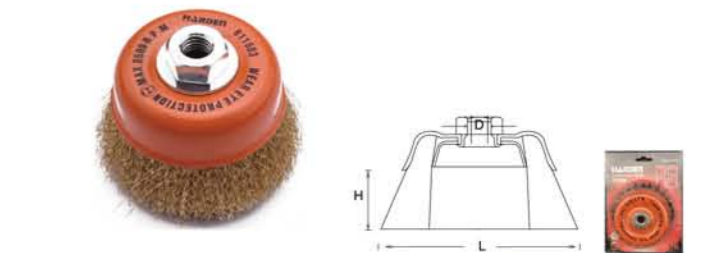

ITEM NO	SIZE mm	THREAD	H mm	Max RPM	Bronze Steel(mm)	PCS	BARCODE
611501	75	M10X1.5	25	12500	0.3	80	6959820848849
611502	75	M14X2	25	12500	0.3	80	6959820848856
611503	100	M14X2	25	8500	0.3	60	6959820848863
611504	125	M14X2	25	6500	0.3	24	6959820848870

**Criped Wire Bevel Brush**

**★ INTRODUCTION**

- \* Ideal for removing rust,paint and varnish from metal surfaces
- \* Wire dia:0.3mm

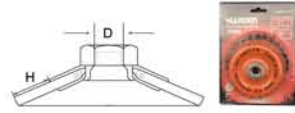

ITEM NO	SIZE	THREAD	H mm	Max RPM	Bronze Steel(mm)	PCS	BARCODE
611505	100MM	M10X1.5	25	12500	0.3	72	6959820848924
611506	100MM	M14X2	25	12500	0.3	72	6959820848931



**Cup Twist Wire Brush With Nut**

**★ INTRODUCTION**

- \* Ideal for removing rust,paint and varnish from metal surfaces
- \* Wire dia:0.5mm

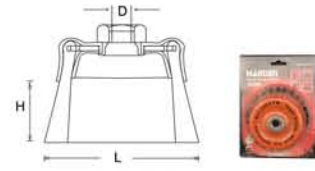

ITEM NO	SIZE	THREAD	H mm	Max RPM	Stainless Steel(mm)	PCS	BARCODE
611511	75	M10X1.5	22	12500	0.5	80	6959820848887
611512	75	M14X2	22	12500	0.5	80	6959820848894
611513	100	M14X2	25	8500	0.5	60	6959820848900
611514	125	M14X2	25	6500	0.5	24	6959820848917



**Twist Wire Bevel Brush**

**★ INTRODUCTION**

- \* Ideal for removing rust,paint and varnish from metal surfaces
- \* Wire dia:0.5mm

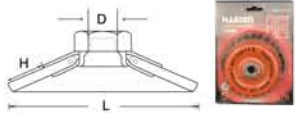

ITEM NO	SIZE	THREAD	H mm	Max RPM	Stainless Steel(mm)	PCS	BARCODE
611516	100MM	M14X2	22	12500	0.5	60	6959820848948



**Criped brush with shank**

**★ INTRODUCTION**

- \* Ideal for removing rust,paint and varnish from metal surfaces
- \* Wire dia:0.3mm
- \* Shank dia:6.35mm(1/4")

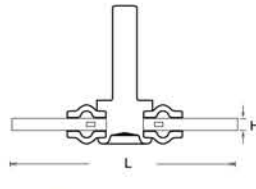

ITEM NO	SIZE	H mm	Max RPM	Bronze Steel(mm)	PCS	BARCODE
611521	50MM	25	4500	0.3	240	6959820848993
611522	75MM	25	4500	0.3	144	6959820849006
611523	100MM	25	4500	0.3	60	6959820849013



**Cup Brush With Shank**

**★ INTRODUCTION**

- \* Ideal for removing rust,paint and varnish from metal surfaces
- \* Wire dia:0.3mm
- \* Shank dia:6.35mm(1/4")

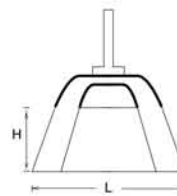

ITEM NO	SIZE	H mm	Max RPM	Bronze Steel(mm)	PCS	BARCODE
611528	50MM	25	4500	0.3	144	6959820849037
611529	75MM	25	4500	0.3	120	6959820849044



**Grass tree wood handle steel wire brush**

**★ INTRODUCTION**

- \* Wood handle
- \* Steel wire 0.33mm,12pcs stainless steel wire

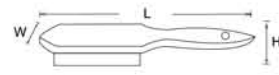

ITEM NO	SIZE	L mm	H mm	W mm	PCS	BARCODE
611543	3rows	295	40	30	120	6959820849730
611544	4rows	295	40	30	120	6959820849747
611545	5rows	295	40	30	120	6959820849754



**4 Grass tree wood handle stainless steel wire brush**

**★ INTRODUCTION**

- \* Wood handle
- \* Stainless steel wire 0.33mm, 12pcs stainless steel wire

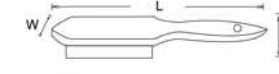

ITEM NO	SIZE	L mm	H mm	W mm	PCS	BARCODE
611554	4rows	295	40	30	120	6959820849761



**Alloy saw blade**

**★ INTRODUCTION**

- \* High carbon steel plate

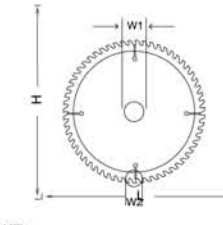

ITEM NO	SIZE	L mm	H mm	W1 mm	W2 mm	PCS	BARCODE
612152	254*120	255	255	25.4	22.2/20	40	6959820850118
612132	305*120	305	305	30	25.4	20	6959820850125



**Flat Wood Bits Set**

**★ INTRODUCTION**

- \*Made from carbon steel, hardened and tempered
- \*Precision polished
- \*1/4" quick release hex shank
- \*Blister card package

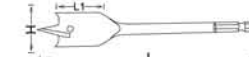

ITEM NO	SIZE	L mm	U mm	H mm	HI mm	PCS	BARCODE
613006	6mm	150	36	6	6.35	250	6959820853942
613008	8mm	150	36	8	6.35	250	6959820853959
613010	10mm	150	36	10	6.35	250	6959820853966
613012	12mm	150	36	12	6.35	250	6959820853973
613013	13mm	150	36	13	6.35	250	6959820853980
613014	14mm	150	38	14	6.35	250	6959820853997
613016	16mm	150	38	16	6.35	250	6959820854000
613018	18mm	150	39	18	6.35	250	6959820854017
613019	19mm	150	39	19	6.35	250	6959820854024
613020	20mm	150	39	20	6.35	250	6959820854031
613022	22mm	150	40	22	6.35	250	6959820854048
613024	24mm	150	43	24	6.35	250	6959820854055
613025	25mm	150	43	25	6.35	250	6959820854062
613028	28mm	150	43	28	6.35	200	6959820854079
613030	30mm	150	44	30	6.35	200	6959820854086
613032	32mm	150	44	32	6.35	200	6959820854093
613035	35mm	150	44	35	6.35	200	6959820854109
613036	36mm	150	44	36	6.35	200	6959820854116
613038	38mm	150	44	38	6.35	150	6959820854123
613040	40mm	150	44	40	6.35	150	6959820854130



**Alloy saw blade**

**★ INTRODUCTION**

- \* Hing carbon steel plate

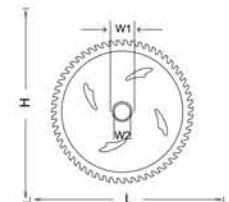

ITEM NO	SIZE	L mm	H mm	W1 mm	W2 mm	PCS	BARCODE
612003	110*30	115	115	20	16	300	6959820850057
612004	110*40	125	125	20	16	300	6959820850064
612016	185*60	180	180	25.4	22.2/20	100	6959820850071
612036	235*60	230	230	25.4	22.2/20	40	6959820850088
612048	254*80	255	255	25.4	22.2/20	40	6959820850095
612058	305*80	305	305	30	25.4	25	6959820850101



**6Pcs Flat Wood Bits Set**

**★ INTRODUCTION**

- \*Made from carbon steel, hardened and tempered
- \*Precision polished
- \*Size: 3/8"(10mm)-1/2"(13mm)-5/8"(16mm)-3/4"(19mm)-7/8"(22mm)-1"(25mm)
- \*1/4" quick release hex shank
- \*Double blister package

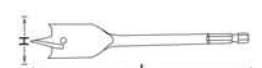

ITEM NO	SIZE	L mm	H mm	PCS	BARCODE
613066	6PCS	150	10/13/16/19/22/25	60	6959820849761



**Tile and Glass Drill Bit**

**★ INTRODUCTION**

- \*YG6X cross carbide tip
- \* Medium carbon steel shank
- \*1/4" quick release hex shank
- \* Sand blasting finished surface
- \* Blister card package

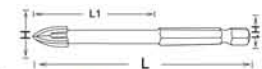

ITEM NO	SIZE	L mm	U mm	H mm	HI mm	PCS	BARCODE
613103	3mm	65	29	3	6.35	500	6959820854321
613104	4mm	71	36	4	6.35	500	6959820854338
613105	5mm	74	38	5	6.35	500	6959820854345
613106	6mm	74	38	6	6.35	500	6959820854352
613107	7mm	75	39	7	6.35	500	6959820854369
613108	8mm	85	49	8	6.35	400	6959820854376
613109	9mm	85	49	9	6.35	400	6959820854383
613110	10mm	85	49	10	6.35	400	6959820854390
613112	12mm	100	64	12	6.35	400	6959820854406





## Paint Brush Plastic Handle

### ★ INTRODUCTION

- \* Paint Brush Plastic Handle
- \* Boiled bristle brush
- \* Two colors Plastic Handle

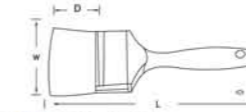

ITEMNO	SIZE	L(mm)	W(mm)	D(mm)	PCS	BARCODE
620101	1"	195	25.5	44	96	6959820835016
620102	2"	200	51.0	44	96	6959820835023
620103	3"	215	76.5	51	72	6959820835030
620104	4"	225	101.5	51	72	6959820835047

## Paint Brush TPR Handle

### ★ INTRODUCTION

- \* Paint Brush TPR Handle
- \* Boiled bristle brush
- \* Two colors TPR handle

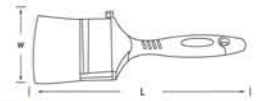

ITEMNO	SIZE	L(mm)	W(mm)	PCS	BARCODE
620121	1"	195	24.5	96	6959820835061
620122	2"	210	52.0	96	6959820835078
620123	3"	220	55.0	72	6959820835085
620124	4"	240	82.0	72	6959820835092

## 4" Paint Roller

### ★ INTRODUCTION

- \* Polyester & Acrylic material
- \* 12mm Roller height
- \* 5.8mm Dia of central shank
- \* 400mm length frame
- \* TPR double color soft handle

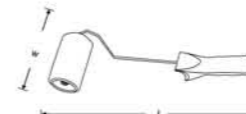

ITEMNO	SIZE(mm)	L(mm)	W(mm)	PCS	BARCODE
620130	4"/100	425	100	120	6959820835030

## 10Pcs 4" Paint Roller Cover set

### ★ INTRODUCTION

- \* Polyester & Acrylic material
- \* 12mm Roller height
- \* Convenient and fast change the roller cover



ITEMNO	SIZE(mm)	L(mm)	W(mm)	PCS	BARCODE
620131	4"/100	100	35	60	6959820850859

## 4" 7Pcs Roller Brush Set

### ★ INTRODUCTION

- \* 3pcs Polyester & Acrylic material
- \* 2pcs White high-density foam roller
- \* 1pc Silver paint tray pp new material
- \* 1pc TPR double color soft handle



ITEMNO	SIZE(mm)	PCS	BARCODE
620133	4"/100	12	6959820847644

## 9" 4Pcs Roller Brush Set

### ★ INTRODUCTION

- \* 1pc Silver paint tray pp new material
- \* 2pcs polyester & acrylic roller
- \* 1pc TPR double color soft handle



ITEMNO	SIZE(mm)	PCS	BARCODE
620134	9"/228	12	6959820847651

9" Paint Roller

★ INTRODUCTION

- \* For Outside wall or coarse wall surface
- \* Acrylic material
- \* 12mm Roller height
- \* 7.8mm Dia of central shank
- \* TPR double color soft handle

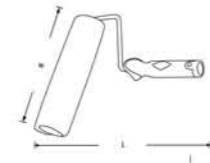

ITEMNO	SIZE(mm)	L(mm)	W(mm)	PCS	BARCODE
620135	9"/100	350	228	36	6959820835115

9" Paint Roller Cover

★ INTRODUCTION

- \* For Outside wall or coarse wall surface
- \* Acrylic material
- \* 12mm Roller height
- \* Convenient and fast change the roller cover
- \* It could be used in conjunction with HARDEN #620139 frame



ITEMNO	SIZE(mm)	L(mm)	W(mm)	PCS	BARCODE
620138	9"/228	228	65	100	6959820835122

9" Paint Roller Frame

★ INTRODUCTION

- \* Steel wire with chrome plated
- \* 7.8mm Dia of central shank
- \* TPR double color soft handle
- \* It could be used in conjunction with HARDEN #620138 cover

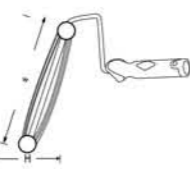

ITEMNO	SIZE(mm)	H(mm)	W(mm)	PCS	BARCODE
620139	9"/100	40	230	40	6959820835139

Wire Brush

★ INTRODUCTION

- \* Wire Brush
- \* Made from copper plating wire
- \* For derusting and polishing

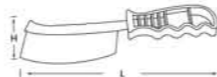

ITEMNO	SIZE(mm)	L(mm)	H(mm)	PCS	BARCODE
620140	225	240	36	72	6959820825055

Stainless Steel Scraper

★ INTRODUCTION

- \* Made from stainless steel
- \* Tempered and quenched
- \* The metal part on the handle can be used for striking

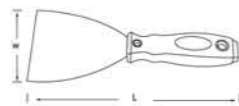

ITEMNO	SIZE(mm)	L(mm)	W(mm)	PCS	BARCODE
620201	25	230	25	120	6959820835146
620202	50	230	50	120	6959820835153
620203	75	230	75	120	6959820835160
620204	100	230	100	120	6959820835177
620205	125	230	125	120	6959820848344

Steel Scraper

★ INTRODUCTION

- \* Made from high carbon steel
- \* Tempered and quenched
- \* The metal part on the handle can be used for striking

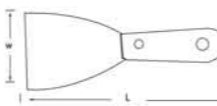

ITEMNO	SIZE(mm)	L(mm)	W(mm)	PCS	BARCODE
620206	25	230	25	240	6959820835146
620207	50	230	50	240	6959820835153
620208	75	230	75	240	6959820835160
620209	100	230	100	240	6959820835177
620210	125	230	125	120	6959820848344

Aluminium Scraper

★ INTRODUCTION

- \* L type design
- \* Comfortable TPR handle
- \* Used with # 570343 blades

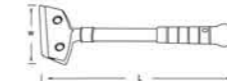

ITEMNO	SIZE(mm)	L(mm)	W(mm)	PCS	BARCODE
620213	300	300	103	72	6959820835184
620214	600	600	103	60	6959820835405

Stainless Steel Scraper

★ INTRODUCTION

- \* #60 steel blade
- \* Rubber cover
- \* Stainless steel tube handle
- \* Used with #620219 blades



ITEMNO	SIZE(mm)	L(mm)	W(mm)	PCS	BARCODE
620217	300	300	100	144	6959820847088
620218	500	500	100	144	6959820847095

Sanding Block

★ INTRODUCTION

- \* Sanding Block
- \* Fixing sand paper
- \* Grinding wall or timber product

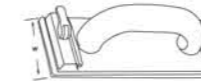

ITEMNO	SIZE(mm)	L(mm)	H(mm)	PCS	BARCODE
620143	230x80	220	83	60	6959820835214

Plastic Scraper

★ INTRODUCTION

- \* Plastic Scraper
- \* Replacable blades
- \* Used with # 620219 blades

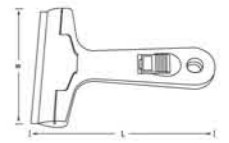

ITEMNO	L(mm)	H(mm)	PCS	BARCODE
620216	145	100	144	6959820835191

Blades For Scraper

★ INTRODUCTION

- \* Blades For Scraper
- \* 65Mn
- \* For #620216



ITEMNO	L(mm)	W(mm)	PCS	BARCODE
620219	100	18	240x10	6959820835207

Bricklaying Trowel

★ INTRODUCTION

- \* High Carbon Steel
- \* TPR Handle



ITEMNO	SIZE	L(mm)	W(mm)	PCS	BARCODE
620226	6"	150	76	60	6959820850378
620227	7"	175	88	60	6959820850385
620228	8"	200	98	60	6959820850392

Bricklaying Trowel

★ INTRODUCTION

- \* High Carbon Steel
- \* TPR Handle



ITEMNO	SIZE	L(mm)	W(mm)	PCS	BARCODE
620236	6"	150	70	48	6959820850408
620237	7"	175	84	48	6959820850415
620238	8"	200	108	48	6959820850422

**Bricklaying Trowel**

★ **INTRODUCTION**

- \* High Carbon Steel
- \* TPR Handle



ITEMNO	SIZE	L(mm)	W1(mm)	W2(mm)	PCS	BARCODE
620246	6"	160	88	115	48	6959820850439
620247	7"	180	90	120	48	6959820850446
620248	8"	200	85	120	48	6959820850453

**Plastering Trowel**

★ **INTRODUCTION**

- \* High Carbon Steel
- \* TPR Handle

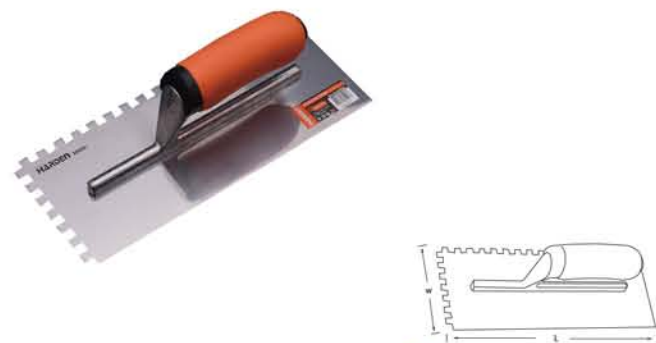

ITEMNO	SIZE(mm)	L(mm)	W(mm)	PCS	BARCODE
620258	280x120	280	120	48	6959820850477

**Plastering Trowel**

★ **INTRODUCTION**

- \* High Carbon Steel
- \* TPR Handle

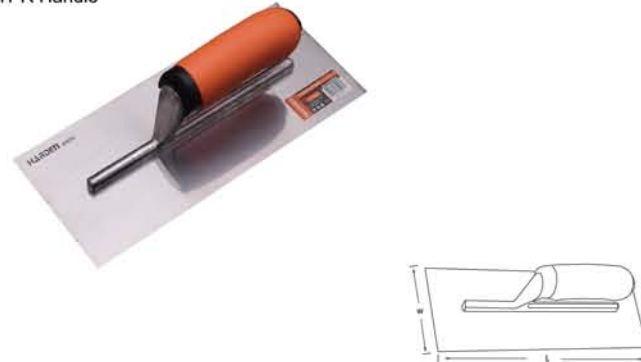

ITEMNO	SIZE(mm)	L(mm)	W(mm)	PCS	BARCODE
620252	280x120	280	120	48	6959820850460

**Foam Gun**

★ **INTRODUCTION**

- \*Aluminium alloy body, metal trigger
- \*Teflon stainless steel needle
- \*The adjusting screw to foam flow fluently
- \*Each one tested by air pressure



ITEMNO	SIZE	L(mm)	W(mm)	PCS	BARCODE
620401	320mm	320	175	20	6959820853782

**9" CAULKING GUN**

★ **INTRODUCTION**

- \*Aluminium body, steel trigger
- \*Ideal for sealing and bonding agents



ITEM NO	SIZE	L(mm)	W(mm)	PCS	BARCODE
620408	9"	340	190	12	6959820852631

**9" Caulking Gun**

★ **INTRODUCTION**

- \* Caulking Gun
- \* Made from fine steel
- \* Applying for sealing or bonding agents



ITEMNO	SIZE	L(mm)	W(mm)	PCS	BARCODE
620409	9"	320	175	24	6959820835221

**9" Caulking Gun**

★ **INTRODUCTION**

- \* Caulking Gun
- \* Made from fine steel
- \* Smooth pushing rod



ITEMNO	SIZE	L(mm)	W(mm)	PCS	BARCODE
620413	9"	320	205	12	6959820835412

**Oval Carpentry Pencil**

★ **INTRODUCTION**

- \* Carpentry pencil orange (021C) surface gold stamped HARDEN words
- \* Graphite black heart



ITEMNO	L mm	W1 mm	W2 mm	PCS	BARCODE
620424	176	12x7.4	5x2	72	6959820848597

**Suction Lifter**

★ **INTRODUCTION**

- \* For lifting,moving hard-to-handle glass, windshields, windows, sheet metal, auto body strong lightweight ABS body,large easy-grip handles sold in pairs



ITEMNO	SIZE	ØD(mm)	PCS	BARCODE
620605	Single Head	118	30	6959820835306

**15" Aluminium Caulking Gun**

★ **INTRODUCTION**

- \* Aluminium Caulking Gun
- \* Made from fine steel
- \* High thrust ratio



ITEMNO	SIZE	L(mm)	W(mm)	PCS	BARCODE
620419	15"	530	210	24	6959820835238

**Oval Carpentry Red Blue Pencil**

★ **INTRODUCTION**

- \* Carpentry pencil red blue
- \* Red side surface gold Stamped HARDEN
- \* Red blue heart



ITEMNO	L mm	W1 mm	W2 mm	PCS	BARCODE
620425	176	10x7.5	4x2	72	6959820848603

**Aluminium Alloy Twin Suction Lifter**

★ **INTRODUCTION**

- \* Twin Suction Lifter reat for lifting,moving hard-to-handle glass, windshields, windows, sheet metal, auto body strong lightweight ABS body,large easy-grip handles sold in pairs



ITEMNO	SIZE	ØD(mm)	PCS	BARCODE
620606	Twin Heads	118	20	6959820835313

Aluminium Alloy Triple Suction Lifter

★ INTRODUCTION



\* Three Suction Lifter reat for lifting,moving hard-to-handle glass, windshields, windows, sheet metal, auto body strong lightweight ABS body,large easy-grip handles sold in pairs



ITEMNO	SIZE	ØD(mm)	PCS	BARCODE
620607	Triple Head	118	12	6959820835320

2Pcs Chalk Line Reel Set

★ INTRODUCTION



\*Length: 30m  
\*With 1 bottle chalk  
\*With 1 pcs spirit bubble  
\*Packed by double blister



ITEM NO	SIZE	PCS	BARCODE
620616	30m/115g	60	6959820853027

Staple Gun

★ INTRODUCTION



\* Three-use nail gun  
\* Made from fine steel  
\* Chrome plating handle  
\* With 600pcs nails  
\* Use staple #620828, #620829

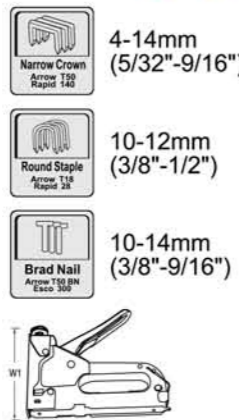

ITEMNO	L mm	W mm	Π mm	T mm	Π mm	PCS	BARCODE
620803	155	113	10-12	10-14	4-14	24	6959820850286

6MX400G Magnetic plumb bob

★ INTRODUCTION



\*For measuring the surface if it's vertical,mainly used for construction work.  
\*In measuring work,it is usually as an appendix to theodolite,total station.  
\*The tip of plumb bob is flexible,when you don't use it, you can make the tip retract.



ITEMNO	SIZE	PCS	BARCODE
620604	6Mx400G	36	6959820835283

Staple Gun

★ INTRODUCTION



\* Made from fine steel  
\* Chrome plating handle  
\* Used with #620836,620838



ITEMNO	L(mm)	W(mm)	Π(mm)	PCS	BARCODE
620802	150	80	4-8	40	6959820850545

Staples type 140

★ INTRODUCTION



\* Carbon Steel  
\* Surface galvanized  
\* Use with #620803

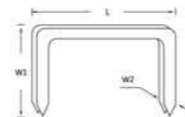

ITEMNO	SIZE(mm)	L(mm)	W1(mm)	W2(mm)	PCS	BARCODE
620828	1,2x8	11,3	8	1,2	200	6959820850521
620829	1,2x10	11,3	10	1,2	200	6959820850576

Staples type 53

★ INTRODUCTION



\* Carbon Steel  
\* Surface galvanized  
\* Use with #620802

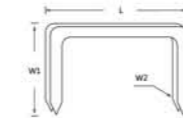

ITEMNO	SIZE(mm)	L(mm)	W1(mm)	W2(mm)	PCS	BARCODE
620836	0.7x6	11.3	6	0.7	200	6959820850552
620838	0.7x8	11.3	8	0.7	200	6959820850569

Crow Bar

★ INTRODUCTION



\* Made from CRV  
\* Sand blasting ,baking varnish and heat treated



ITEMNO	SIZE(mm)	L(mm)	W(mm)	PCS	BARCODE
620715	600	600	30	6	6959820822245
620717	900	900	30	6	6959820822252

Hex Paint Mixer

★ INTRODUCTION



\*Carbon steel  
\*Zinc plating  
\*Plastic hanging card



ITEMNO	SIZE(mm)	L(mm)	W(mm)	PCS	BARCODE
621004	400x80x8	400	80	40	6959820853799
621006	600x100x9	600	100	20	6959820853805

Wrecking Bar

★ INTRODUCTION



\* Made from high carbon steel  
\* Powder coated and heat treated

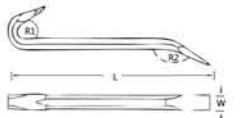

ITEMNO	SIZE	L(mm)	W(mm)	PCS	BARCODE
620706	20X600mm	600	20	6	6959820821873
620710	20X1000mm	1000	20	6	6959820821880

Crow Bar

★ INTRODUCTION



\* Made from high carbon steel  
\* Powder coated and heat treated



ITEMNO	SIZE	L(mm)	W(mm)	PCS	BARCODE
620718	20X800mm	800	20	4	6959820821897
620725	25X1500mm	1500	25	4	6959820821903

SDS-PLUS Paint Mixer

★ INTRODUCTION



\*\*Carbon steel  
\*Zinc plating  
\*Plastic hanging card



ITEMNO	SIZE(mm)	L(mm)	W(mm)	PCS	BARCODE
621014	400x80x10	400	80	40	6959820853812
621016	600x100x10	600	100	20	6959820853829



**Clear Bopp Packing Tape**

★ **INTRODUCTION**

- \*Superb adhesion to surface.
- \*Used for carton sealing
- \*Transparent
- \*Six rolls packed by shrink



ITEMNO	SIZE	ØD(mm)	PCS	BARCODE
621103	30m	48	72	6959820853034
621105	50m	48	72	6959820853041
621110	100m	48	54	6959820853058

**Clear HARDEN logo Bopp Packing Tape**

★ **INTRODUCTION**

- \*Superb adhesion to surface.
- \*Used for carton sealing
- \*Transparent
- \*Six rolls packed by shrink



ITEMNO	SIZE	ØD(mm)	PCS	BARCODE
621310	100m	48	54	6959820853133

**2Pcs Luggage Rope Set**

★ **INTRODUCTION**

- \*Material: rubber
- \*Diameter: 8mm
- \*Hook: 3.2mm, with protective caps
- \*Packing: PVC bag with paper hanger



ITEMNO	SIZE	L(mm)	ØD(mm)	PCS	BARCODE
622124	24"	600-1000	32	48	6959820852884
622136	36"	900-1600	32	48	6959820852891
622148	48"	1200-2200	32	48	6959820852907

**Iron Padlock**

★ **INTRODUCTION**

- \*Made from Iron
- \*With 3 pcs keys
- \*Skin card package



ITEMNO	SIZE	L(mm)	H(mm)	ØD(mm)	PCS	BARCODE
622332	32mm	32	50	14	120	6959820854239
622338	38mm	38	60	16	120	6959820854246
622350	50mm	50	75	20	72	6959820854253
622363	60mm	60	95	23	36	6959820854260

**Brown Bopp Packing Tape**

★ **INTRODUCTION**

- \*Superb adhesion to surface.
- \*Used for carton sealing
- \*Brown
- \*Six rolls packed by shrink



ITEMNO	SIZE	ØD(mm)	PCS	BARCODE
621205	50m	48	72	6959820853065
621210	100m	48	54	6959820853072

**Masking Tape**

★ **INTRODUCTION**

- \*Superb adhesion to surface.
- \*Used for carton sealing
- \*Transparent
- \*Six rolls packed by shrink



ITEMNO	SIZE	ØD(mm)	PCS	BARCODE
621618	30m	18	153	6959820853089
621624	30m	24	108	6959820853096
621636	30m	36	72	6959820853102
621648	30m	48	54	6959820853119

**Brass Padlock**

★ **INTRODUCTION**

- \*Made from brass
- \*Hardened steel shackle, chrome plated
- \*Double bolted, Rustproof interior
- \*With 3 pcs brass keys
- \*Skin card package



ITEMNO	SIZE	L(mm)	H(mm)	ØD(mm)	PCS	BARCODE
622520	20mm	20	35	10	240	6959820854277
622530	30mm	30	55	11	240	6959820854284
622540	40mm	40	60	12	120	6959820854291
622550	50mm	50	75	14	120	6959820854307
622560	60mm	60	90	16	72	6959820854314

**φ12mmx1m Bicycle Lock**

★ **INTRODUCTION**

- \*PVC wirerope, brass lock cylinder
- \*ABS case
- \*With 2pcs keys
- \*Tie card package



ITEMNO	SIZE	PCS	BARCODE
622601	φ12mmx1m	50	6959820853034



**Garden Pruner**

★ **INTRODUCTION**



- \* Forged from 65Mn steel
- \* Heat treated blade, sharp and durable
- \* PVC coated handle



ITEMNO	SIZE(mm)	L(mm)	W1(mm)	W2(mm)	PCS	BARCODE
630401	8"	200	27.5	50	48	6959820816954

**Gardem By-Pass Pruner**

★ **INTRODUCTION**



- \* Upper blade: SK5 steel, Non-stick painting
- \* Lower blade: carbon steel
- \* Comfortable handle with TPR grip



ITEMNO	SIZE	L(mm)	W1(mm)	W2(mm)	PCS	BARCODE
630402	8"	200	30	77.5	48	6959820816961

**Garden Anvil Pruner**

★ **INTRODUCTION**



- \* Upper blade: SK5 steel, Non-stick painting
- \* Lower blade: carbon steel
- \* Comfortable handle with TPR grip



ITEMNO	SIZE	L(mm)	W1(mm)	W2(mm)	PCS	BARCODE
630403	8"	200	30	77.5	48	6959820816978

**Garden Pruner**

★ **INTRODUCTION**



- \* Upper blade: SK5 steel, Non-stick painting
- \* Lower blade: carbon steel
- \* Comfortable handle with TPR grip



ITEMNO	SIZE	L(mm)	W1(mm)	W2(mm)	PCS	BARCODE
630405	8"	200	30	48	48	6959820816985

**Garden Fruit Shears**

★ **INTRODUCTION**



- \* Forged stainless steel blade
- \* Heat treated for sharp and durable use
- \* Zinc alloy handle with PVC cover



ITEMNO	SIZE(mm)	L(mm)	W1(mm)	W2(mm)	PCS	BARCODE
630415	200	200	40	50	72	6959820817630

**Garden Fruit Shears**

★ **INTRODUCTION**



- \* Forged stainless steel blade
- \* Heat treated for sharp and durable use
- \* Zinc alloy handle with PVC cover



ITEMNO	SIZE(mm)	L(mm)	W1(mm)	W2(mm)	PCS	BARCODE
630416	200	200	30	35	72	6959820817647

**Mini By-pass Pruner**

★ **INTRODUCTION**



- \* High Carbon Steel
- \* PP&TPR Handle
- \* Cut Range: ≤ 25mm wood



ITEMNO	SIZE	L(mm)	W1(mm)	W2(mm)	PCS	BARCODE
630501	15"	400	38	170	12	6959820850330

**Hedge Shear**

★ **INTRODUCTION**



- \* Stainless Steel Blades
- \* 6 position rotation
- \* ABS handle



ITEMNO	SIZE	L(mm)	W1(mm)	W2(mm)	PCS	BARCODE
630503	13.5"	340	130	66	48	6959820850361

**Hedge Shear**

★ **INTRODUCTION**



- \* 300mm x 4mm high quality carbon steel blade
- \* Heat treated for sharp and durable use
- \* Comfortable rubber handle



ITEMNO	SIZE	L(mm)	W1(mm)	W2(mm)	PCS	BARCODE
630502	25"	640	83.6	220	12	6959820816992

**By-pass Lopping Pruner**

★ **INTRODUCTION**



- \* High Carbon Steel
- \* PP&TPR Handle
- \* Cut Range: ≤ 35mm wood



ITEMNO	SIZE	L1(mm)	L2(mm)	W1(mm)	W2(mm)	PCS	BARCODE
630505	25"	645	135	47	280	6	6959820850354

**Anvil Lopping Pruner**

★ **INTRODUCTION**



- \* #65 Mn high carbon steel teflon blade
- \* PP&TPR Handle
- \* Cut Range: ≤ 45mm wood



ITEMNO	SIZE	L1(mm)	L2(mm)	W1(mm)	W2(mm)	PCS	BARCODE
630506	30.5"	770	200	55	320	12	6959820850323

**CUTTING MORE SHARP**



Tree Trimmer

★ INTRODUCTION



- \* Made from high carbon steel with two side teeth grinding
- \* Fixed with telescopic tubular handle and 3M nylon rope



ITEMNO	SIZE	PCS	BARCODE
630512	1.27M-2.4M	12	6959820817609

Pro Hand Saw

★ INTRODUCTION



- \* Made of #65 Mn steel, heat treated
- \* Saw teeth hardness >Hrc53, hardened and sharp
- \* Three sides grinding tooth, sharp and more quickly remove the chip
- \* Soft feeling TPR handle



ITEMNO	SIZE	L1(mm)	L2(mm)	L3(mm)	W(mm)	PCS	BARCODE
631116	16"	490	332	400	40	24	6959820847361
631118	18"	540	387	450	40	24	6959820847378
631120	20"	570	415	500	40	24	6959820847385

Mini Hand Saw

★ INTRODUCTION



- \* Made of #65 Mn steel, heat treated
- \* Saw teeth hardness >Hrc53, hardened and sharp
- \* Two sides grinding tooth, sharp and more quickly remove the chip
- \* Soft feeling TPR handle



ITEMNO	SIZE	L1(mm)	L2(mm)	PCS	BARCODE
631227	270mm	470	310	24	6959820847408

Hand Saw

★ INTRODUCTION



- \* Made of #65 Mn steel, heat treated
- \* Saw teeth hardness >Hrc53, hardened and sharp
- \* Two sides grinding tooth, sharp and more quickly remove the chip
- \* Soft feeling TPR handle



ITEMNO	SIZE	L1(mm)	L2(mm)	L3(mm)	W(mm)	PCS	BARCODE
631014	14"	450	290	350	40	48	6959820847316
631016	16"	495	335	400	40	48	6959820847323
631018	18"	540	385	450	40	48	6959820847330
631020	20"	600	435	500	40	48	6959820847347
631022	22"	640	482	550	40	48	6959820847354

Wall Board Saw

★ INTRODUCTION



- \* Made of #65 Mn steel, heat treated
- \* Saw teeth hardness >Hrc53, hardened and sharp
- \* Two sides grinding tooth, sharp and more quickly remove the chip
- \* Soft feeling TPR handle



ITEMNO	SIZE	L1(mm)	L2(mm)	PCS	BARCODE
631215	6"/150mm	310	160	36	6959820847392

Folding Saw

★ INTRODUCTION



- \* Made of #65 Mn steel, heat treated
- \* Three sides grinding tooth, sharp and more quickly remove the chip
- \* Soft feeling TPR handle



ITEMNO	SIZE	L1(mm)	L2(mm)	PCS	BARCODE
631301	7"/180mm	405	180	48	6959820847583

Folding Saw

★ INTRODUCTION



- \* Made of #65 Mn steel, heat treated
- \* Three sides grinding tooth, sharp and more quickly remove the chip
- \* Soft feeling TPR handle



ITEMNO	SIZE	L1(mm)	L2(mm)	PCS	BARCODE
631302	7"/180mm	395	180	36	6959820847590

Garden Glove

★ INTRODUCTION



- \* Comfort ventilatin
- \* Good elasticity of high quality wrist



ITEMNO	SIZE	PCS	BARCODE
634101	9"	300	6959820847613

Bottle Sprayer

★ INTRODUCTION



- \* All copper nozzle, convenient and durable



ITEMNO	SIZE	PCS	BARCODE
632501	1.0L	20	6959820847422
632502	2.0L	20	6959820847439

Bend Saw

★ INTRODUCTION



- \* Made of #65 Mn steel, heat treated
- \* Three sides grinding tooth, sharp and more quickly remove the chip
- \* Soft feeling TPR handle



ITEMNO	SIZE	L1(mm)	L2(mm)	PCS	BARCODE
631303	12"	495	330	36	6959820847606

Garden Glove

★ INTRODUCTION



- \* Comfort ventilatin
- \* Good elasticity of high quality wrist



ITEMNO	SIZE	PCS	BARCODE
634102	10"	300	6959820847620

Pressure Sprayer

★ INTRODUCTION



- \* The pneumatic rod is made of stainless steel
- \* All copper nozzle, convenient and durable



ITEMNO	SIZE	PCS	BARCODE
632505	5L	6	6959820847446

**Mini Garden Shovel**

★ **INTRODUCTION**

- \* Carbon steel, heat treated
- \* Black powder coating
- \* Comfort TPR grip

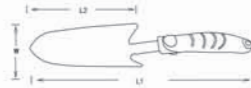

ITEMNO	SIZE	L1(mm)	L2(mm)	W(mm)	PCS	BARCODE
632601	350x75mm	350	170	75	48	6959820847521

**Garden Trowel**

★ **INTRODUCTION**

- \* Carbon steel, heat treated
- \* Black powder coating
- \* Comfort TPR grip

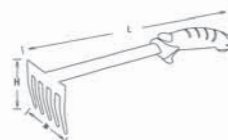

ITEMNO	SIZE	L1(mm)	H(mm)	W(mm)	PCS	BARCODE
632603	350x87mm	350	71	87	72	6959820847545

**Garden Hoe**

★ **INTRODUCTION**

- \* Carbon steel, heat treated
- \* Black powder coating
- \* Comfort TPR grip

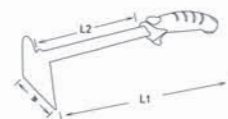

ITEMNO	SIZE	L1(mm)	L2(mm)	W(mm)	PCS	BARCODE
632605	340x100mm	340	170	80	120	6959820847569

**Garden Shovel**

★ **INTRODUCTION**

- \* Carbon steel, heat treated
- \* Black powder coating
- \* Comfort TPR grip

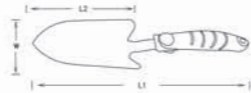

ITEMNO	SIZE	L1(mm)	L2(mm)	W(mm)	PCS	BARCODE
632602	350x85mm	350	170	85	48	6959820847538

**Garden Combination Hoe**

★ **INTRODUCTION**

- \* Carbon steel, heat treated
- \* Black powder coating
- \* Comfort TPR grip

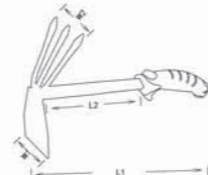

ITEMNO	SIZE	L1(mm)	L2(mm)	W1(mm)	W2(mm)	PCS	BARCODE
632604	340x180mm	340	180	60	60	48	6959820847552

**Stainless Spade**

★ **INTRODUCTION**

- \* Stainless steel, heat treated
- \* Mirror polish
- \* Comfort TPR grip

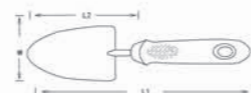

ITEMNO	SIZE	L1(mm)	L2(mm)	W(mm)	PCS	BARCODE
632702	320x80mm	320	140	80	48	6959820851313

**Stainless Combination Hoe & Fork**

★ **INTRODUCTION**

- \* Stainless steel, heat treated
- \* Mirror polish
- \* Comfort TPR grip

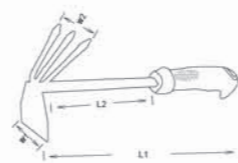

ITEMNO	SIZE	L1(mm)	L2(mm)	W1(mm)	W2(mm)	PCS	BARCODE
632704	320x185mm	320	145	75	50	48	6959820851320

**ELECTRONIC TOOLS**



**Test Pencil**

**★ INTRODUCTION** 

- \* Quality steel probe for durability
- \* Application: For vltage range 110-250VAC



ITEMNO	SIZE(mm)	L(mm)	PCS	BARCODE
660001	145	145	480	6959820840010
660002	190	190	480	6959820840027

**Dual-purpose Tester**

**★ INTRODUCTION** 

- \* Quality chrome vanadium probe for durability
- \* Application: For vltage range 80-550V
- \* Flat and phillips screwdriver for more option



ITEMNO	SIZE(mm)	L(mm)	PCS	BARCODE
660007	205	210	120	6959820840041

**Multifunctional Tester**

**★ INTRODUCTION** 

- \* Digital screen for easy reading
- \* Quality chrome vanadium probe for durability
- \* Application: For vltage range less than 12-250V



ITEMNO	SIZE	L(mm)	PCS	BARCODE
660011	12-250V	210	240	6959820840812

**Non-Contact Detector**

**★ INTRODUCTION** 

- \* Fire-proof ABS cover
- \* For voltage range 90-1000V
- \* Twin color flickers, acoustic and optical alarm signaler,breakpoint
- \* Help to prevent unnecessary damage to decoration



ITEMNO	SIZE	L(mm)	PCS	BARCODE
660021	90-1000V	210	96	6959820835399

**Straight Stainless Knife**

**★ INTRODUCTION** 

- \* For use on soft cable and also be used for stripping, cutting insulation materials electrical tape
- \* Stainless steel blad with hardened



ITEMNO	SIZE(mm)	L(mm)	PCS	BARCODE
660101	205	205	60	6959820840058

**Curved Stainless Knife**

**★ INTRODUCTION** 

- \* For use on soft cable and also be used for stripping, cutting insulation materials electrical tape
- \* Stainless steel blad with hardened



ITEMNO	SIZE(mm)	L(mm)	PCS	BARCODE
660102	195	195	72	6959820840065

**Electrical Knife**

**★ INTRODUCTION** 

- \* Stainless steel blade with hardened edge for long lasting usage
- \* For use on soft cable and also be used for stripping, cutting insulation materials, electrical tape and cable ties



ITEMNO	SIZE(mm)	L(mm)	L2(mm)	W(mm)	PCS	BARCODE
660103	195	195	88	26.5	120	6959820835375

**Curved Stainless Knife**

**★ INTRODUCTION** 

- \* Stainless steel blade with hardened edge for long lasting usage
- \* For use on soft cable and also be used for stripping, cutting insulation materials, electrical tape and cable ties



ITEMNO	SIZE(mm)	L(mm)	L2(mm)	W(mm)	PCS	BARCODE
660105	185	185	76	26.5	120	6959820835382

**Anti-Static Stainless Steel Tweezer**

**★ INTRODUCTION** 

- \* High quality stainless steel
- \* Anti-static
- \* Excellent elasticity, durable for use



ITEMNO	SIZE(mm)	L(mm)	W(mm)	PCS	BARCODE
660211	120	120	11	1000	6959820840133

**Anti-Static Stainless Steel Tweezer**

**★ INTRODUCTION** 

- \* High quality stainless steel
- \* Anti-static
- \* Excellent elasticity, durable for use



ITEMNO	SIZE(mm)	L(mm)	W(mm)	PCS	BARCODE
660212	120	120	11	1000	6959820840140

**Anti-Static Stainless Steel Tweezer**

**★ INTRODUCTION** 

- \* High quality stainless steel
- \* Anti-static
- \* Excellent elasticity, durable for use



ITEMNO	SIZE(mm)	L(mm)	W(mm)	PCS	BARCODE
660213	120	120	11	1000	6959820840157

**Anti-Static Stainless Steel Tweezer**

**★ INTRODUCTION** 

- \* High quality stainless steel
- \* Anti-static
- \* Excellent elasticity, durable for use



ITEMNO	SIZE(mm)	L(mm)	W(mm)	PCS	BARCODE
660215	125	125	11	1000	6959820840164

Anti-Static Wrist Strap

★ INTRODUCTION

- \* Elastic
- \* Anti-static
- \* Nickel plating



ITEMNO	SIZE(mm)	PCS	BARCODE
660226	700	100	6959820840218

Stainless Tweezers

★ INTRODUCTION

- \* High quality stainless steel
- \* Anti-magnetic
- \* For medical, cosmetic, electrical, assemble, agricultural, etc use



ITEMNO	SIZE(mm)	PCS	BARCODE
660231	118	1000	6959820825338
660232	125	1000	6959820825345
660233	120	1000	6959820825352

4Pcs Stainless Tweezers Set

★ INTRODUCTION

- \* High quality stainless steel
- \* Anti-magnetic
- \* For medical, cosmetic, electrical, assemble, agricultural, etc use



ITEMNO	PCS	BARCODE
660238	200	6959820825369

3Pcs Brush Set

★ INTRODUCTION

- \* Including nylon brush, steel brush and brass brush
- \* For heavy duty cleaning use of tubes struts, awkward places

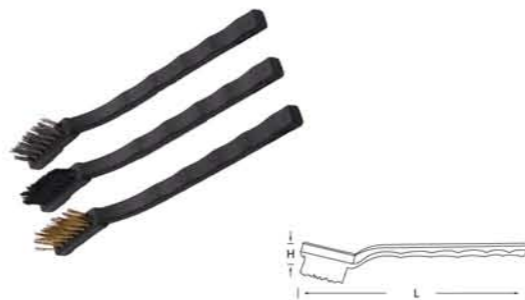

ITEMNO	L(mm)	H(mm)	PCS	BARCODE
660241	175	10	120	6959820825048

Spring Magnet Pickup

★ INTRODUCTION

- \* Spring Magnet Pickup
- \* High power magnet slimline contoured handle



ITEMNO	SIZE(mm)	L1(mm)	L2(mm)	W(mm)	PCS	BARCODE
660245	600	600	500	34	48	6959820825116

Magnet Pickup

★ INTRODUCTION

- \* Telescopic Magnetic Pickup
- \* Pen type handle with pocket clip



ITEMNO	SIZE	L(mm)	H(mm)	PCS	BARCODE
660246	135-640mm	640	13	144	6959820825123
660247	170-830mm	840	14	144	6959820825130

Pickup Mirror

★ INTRODUCTION

- \* Ball and socket universally positional joint holds the high grade distortion free mirror at any angle
- \* Multi-direction head for awkward places



ITEMNO	SIZE	L(mm)	H(mm)	PCS	BARCODE
660248	175-490mm	500	12	144	6959820825147

Soldering Iron

★ INTRODUCTION

- \* Thermo-plastic handles for comfort and a firm safe grip
- \* All purpose soldering iron for general electrical repairs in the workshop



ITEMNO	SIZE	L1(mm)	L2(mm)	H1(mm)	H2(mm)	PCS	BARCODE
660323	100W	1650	255	7.5	29	48	6959820840287
660326	200W	1700	310	15.0	32	24	6959820840300
660327	300W	1700	335	18.0	32	24	6959820840317

Solder Wire Rosin Core

★ INTRODUCTION

- \* Tin-Lead solder bar
- \* Excellent solderability properties
- \* Low occurrences of spattering of flux and solder particles



ITEMNO	SIZE(mm)	PCS	BARCODE
660355	0.8mm/100G	200	6959820840331
660356	1.0mm/250G	100	6959820840348

Soldering Iron With Light

★ INTRODUCTION

- \* Thermo-plastic handles for comfort and a firm safe grip
- \* All purpose soldering iron for general electrical repairs in the workshop



ITEMNO	SIZE	L1(mm)	L2(mm)	H1(mm)	H2(mm)	PCS	BARCODE
660301	30W	1650	200	4.8	23.5	96	6959820840225
660302	40W	1620	200	3.8	23.5	100	6959820840232
660303	60W	1670	245	6.8	28.6	100	6959820840249

Resin Solder Dispenser

★ INTRODUCTION

- \* Tin-Lead solder bar
- \* Excellent solderability properties
- \* Low occurrences of spattering of flux and solder particles



ITEMNO	SIZE	PCS	BARCODE
660351	1.0mm/17G	600	6959820840324

Hot Air Gun

★ INTRODUCTION

- \* Standing upright on a work surface so that both your hands are free
- \* Precision heat control for paint stripping, shrink wrapping, drying out wet timber or defrosting



ITEMNO	SIZE	L(mm)	W1(mm)	W2(mm)	PCS	BARCODE
660361	2000W	270	34.5	71.7	12	6959820840362

**Aluminium Manul Tin Extractor**

★ INTRODUCTION



- \* Extractor spring located outside the vacuum chamber and PTFE nozzle to prevent solder sticking
- \* With carbon impregnated tip and body to prevent solder adhesion and dispel static



ITEMNO	L(mm)	W(mm)	PCS	BARCODE
660363	195	20.8	400	6959820840379

**60-100W Glue Gun**

★ INTRODUCTION



- \* Hot melt trigger fed glue gun with foldaway stand
- \* Ideal for light duty carbon sealing, also can be used on wood, plastic, ceramics, card, glass, fabrics and leather
- \* Suit HARDEN 660372 Glue Sticks

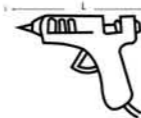

ITEMNO	SIZE	L(mm)	H(mm)	PCS	BARCODE
660371	60-100W	190	165	40	6959820840386

**100x2.5mm Cable Ties/White**

★ INTRODUCTION



- \* Suitable for securing or retaining cables and objects of various shapes and sizes
- \* Tensile strength of 8 to 22kgs
- \* Supplied in pack of 100



ITEMNO	SIZE	PCS	BARCODE
660401	100mm/100PC	500	6959820840409
660402	150mm/100PC	400	6959820840416
660403	200mm/100PC	200	6959820840423
660405	300mm/100PC	150	6959820840430

**30W Glue Gun**

★ INTRODUCTION



- \* Ceramic heater
- \* Hot melt trigger fed glue gun with foldaway stand
- \* Ideal for light duty carbon sealing, also can be used on wood, plastic, ceramics, card, glass, fabrics and leather etc.
- \* Suit HARDEN 660373 Glue Sticks



ITEMNO	SIZE	L(mm)	H(mm)	PCS	BARCODE
660370	30W	145	115	48	6959820850835

**Glue Sticks**

★ INTRODUCTION



- \* A general purpose adhesive, can be used with many materials such as paper, card, wood, cork, leather, fabrics, plastic and ceramics
- \* Suit HARDEN 660370 660371 glue gun

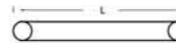

ITEMNO	SIZE	L(mm)	ØH(mm)	PCS	BARCODE
660372	200mm/6PC	200	11	120	6959820840393
660373	150mm/30PC	150	7	100	6959820850866

**100x2.5mm Cable Ties/Black**

★ INTRODUCTION



- \* Suitable for securing or retaining cables and objects of various shapes and sizes
- \* Tensile strength of 8 to 22kgs
- \* Supplied in pack of 100



ITEMNO	SIZE	PCS	BARCODE
660411	100mm/100PC	500	6959820840447
660412	150mm/100PC	400	6959820840454
660413	200mm/100PC	200	6959820840461
660415	300mm/100PC	150	6959820840478

**Pvc Tape**

★ INTRODUCTION



- \* Various color to choose
- \* 20m long
- \* Using under 600 volt indoor and outdoor



ITEMNO	SIZE	PCS	BARCODE
660501	20M(Black)	10	6959820840607
660502	20M(Red)	10	6959820840614

**Grinding Stripper Series**

★ INTRODUCTION



- \* Stripping tool adjusts automatically to the diameter of the wire
- \* Wire diameter range 2.6mm



ITEMNO	SIZE	L(mm)	W(mm)	PCS	BARCODE
660620	6.5"	162	48	12	6959820840842

**Grinding Stripper Series**

★ INTRODUCTION



- \* Updated precise stripping knife blades has tiny holes
- \* Differ from traditional wire strippers, this product is made of quality steel, not only cutting precision, and extended service life
- \* Can not guarantee the accuracy of mobile fulcrum stripping diameter
- \* Cut cable convenient fast, and accurate.

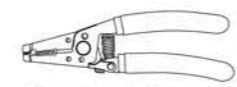

ITEMNO	SIZE	L(mm)	W(mm)	PCS	BARCODE
660623	7.5"	180	58	60	6956820840873

**Automatic Wire Stripper**

★ INTRODUCTION



- \* Clamp body made of zinc alloy
- \* Clamp made of chrome molybdenum steel, hardness 55-60
- \* Parameters information (0.2-6MM<sup>2</sup> / 24-10AWG).

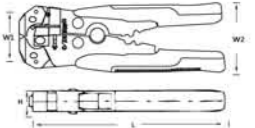

ITEMNO	L(mm)	W(mm)	W2(mm)	H(mm)	RANGE	PCS	BARCODE
660613	205	45	107	25	0.2-6MM <sup>2</sup>	6	6959820850293

**Wire Stripper**

★ INTRODUCTION



- \* Stripping tool adjusts automatically to the diameter of the wire
- \* Wire diameter range 2.6mm



ITEMNO	SIZE(mm)	L(mm)	W(mm)	PCS	BARCODE
660621	175	175	61	60	6959820840669

**Electric Scission**

★ INTRODUCTION



- \* For use on soft cable up to 22mm diameter and also be used stripping, cutting insulating materials, electrical tap and cable ties

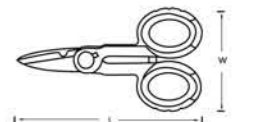

ITEMNO	SIZE(mm)	L(mm)	W(mm)	PCS	BARCODE
660625	138	175	61	72	6959820835368

**Cable Strippers**

★ INTRODUCTION



- \* Updated precise stripping knife hole, stripping diameter 1.5-4 square
- \* Differ from traditional wire strippers, this product is made of quality steel, not only cutting precision, and extended service life
- \* Cut cable convenient, fast, and accurate
- \* Can cut PPR/PVC pipe



ITEMNO	SIZE	L(mm)	W(mm)	PCS	BARCODE
660627	8"	185	53	60	6959820840850

**Modular Plug Crimping Tools**

★ INTRODUCTION



- \* Manufacturing from hardened and tempered carbon steel with chemically black finished jaws with PVC handles
- \* Complete with wire cutting and stripping facilities
- \* RJ45,RJ11,RJ12 (6P) (8P) (4P)

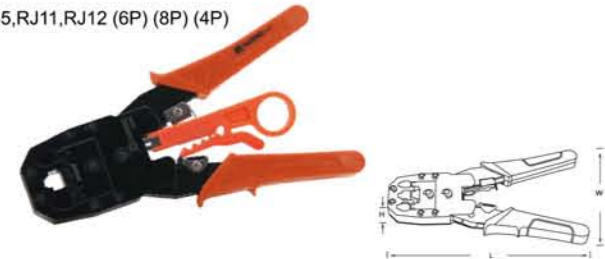

ITEMNO	SIZE(mm)	L(mm)	W(mm)	H(mm)	PCS	BARCODE
660631	190	190	107.6	16.3	48	6959820840859

**Digital Multimeter**

★ INTRODUCTION



- \* IEC 61010-1 CAT.II 600V
- \* Auto Polarity
- \* 3 1/2 Digits LCD, Max display 1999
- \* Backlight Large LCD display
- \* Low Battery indication
- \* Overload protection
- \* Data-hold mode
- \* Auto power off
- \* Specifications
- DC Voltage: 200m/2/20/200/300V
- AC Voltage: 200/600V
- DC Current: 200µ/2m/20m/200m/10A
- Resistance: 200/2k/20k/200k/2M/20MΩ
- Continuity Test
- Diode Test Transistor hFE test
- Battery : 6F22(9V) included
- Test lead: plug black & red
- CE approved



**Multifunction Crimp Strippers**

★ INTRODUCTION



- \* Using high-quality chrome vanadium steel, novel appearance
- \* Crimping insulated terminals and bare terminals, fast and efficient



ITEMNO	SIZE	L(mm)	W(mm)	PCS	BARCODE
660629	0.6-2.0mm	190	59	60	6956820840866

**Work flashlight**

★ INTRODUCTION



- \*Material: aluminum body
- \*Battery voltage: 1.5V
- \*Baery type: 1pc AA
- \*Lamp bead: 1watt LED
- \*Brightness: 30 Lumen
- \*Hook for hang in pocket
- \*With 1pc AA alkaline battery



ITEMNO	SIZE	L(mm)	W(mm)	H(mm)	PCS	BARCODE
660708	1.5V	95	20	20	120	6959820852280

**Ratchet Crimping Pliers**

★ INTRODUCTION



- \* Ferrule crimp tool with full cycle ratcheting crimp frame and adjustable crimp pressure Carbon steel jaws with a chemically balcked finish and PVC handles



ITEMNO	SIZE(mm)	RANGE	RANGE	PCS	BARCODE
660641	215	Wire insulation terminal	1/2/5 mm <sup>2</sup>	48	6959820840683
660642	215	Naked terminal	0.15-0.5/0.5-1.5/1.5-2.5/4-6mm <sup>2</sup>	48	6959820840690
660643	215	Coaxial cable crimp	0.42/0.68/0.78/1.28/1.51/1.78mm <sup>2</sup>	48	6959820840706
660644	215	Wire insulation terminal	0.5-1.5/2.5/4/6mm <sup>2</sup>	48	6959820840713
660645	215	Coaxial cable crimp	0.256/0.319/0.068/0.218mm <sup>2</sup>	48	6959820840720
660646	215	Wire insulation terminal	0.5-1.5/1.5-2.5/4-6mm <sup>2</sup>	48	6959820840737
660647	215	Closed end wire	0.5/1/1.5/2.5/4/6/10mm <sup>2</sup>	48	6959820840744
660648	215	Round tubular terminal	0.5/1/1.5/2.5/4/6mm <sup>2</sup>	48	6959820840751
660649	215	Combined end terminal	0.5/1/1.5/2.5/4/6/10mm <sup>2</sup>	48	6959820840768
660650	215	Coaxial cable crimp	0.213/0.068/0.187/0.255mm <sup>2</sup>	48	6959820840775

**Digital Clamp Multimeter**

★ INTRODUCTION



- \* Auto Polarity
- \* 3 1/2 Digits LCD, Max display 1999
- \* Backlight Large LCD display
- \* Low Battery indication
- \* Overload protection
- \* Data-hold mode
- \* Auto power off
- \* Specifications
- DC Voltage: 200m/2/20/200/300V
- AC Voltage: 200/600V
- DC Current: 200µ/2m/20m/200mA
- AC Current: 220uA-200mA (lead test)
- AC Current: 2/20/200/1000A (clmap test)
- Resistance: 200/2k/20k/200k/2M/20MΩ
- Continuity Test
- Diode Test
- Battery : 3x1.5AA Alkaline batteries included
- Test letad: plug black & red
- CE approved



ITEMNO	SIZE	L(mm)	H(mm)	PCS	BARCODE
661003	200mA/200/600V	250	90	30	6959820852327

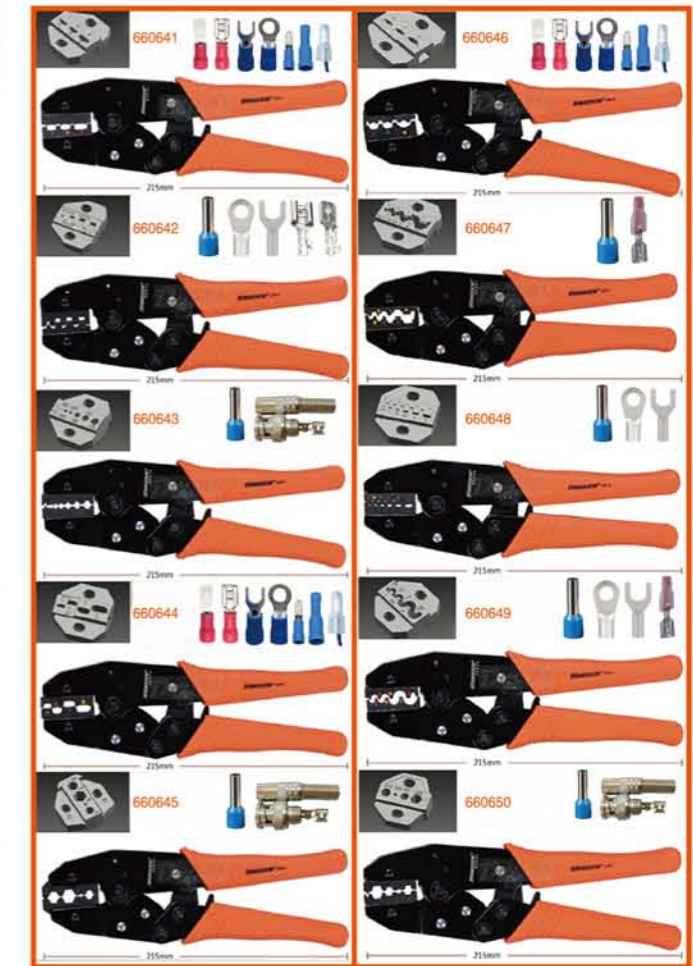

**Pocket Digital Multimeter**

Overview OPERATING MANUAL

Digital Multimeter Model (hereafter referred to as "the Meter") can measure AC/DC Voltage, DC Current, Resistance, Continuity, Diodes, Transistor hFE and so on. The Meter complies with the standards IEC 61010-1. It's portable and has large LCD display, blue backlight, data hold and with PVC protection holder. As an ideal tool, it can service well in field of maintenance of auto, electrical engineering and teaching lab etc.

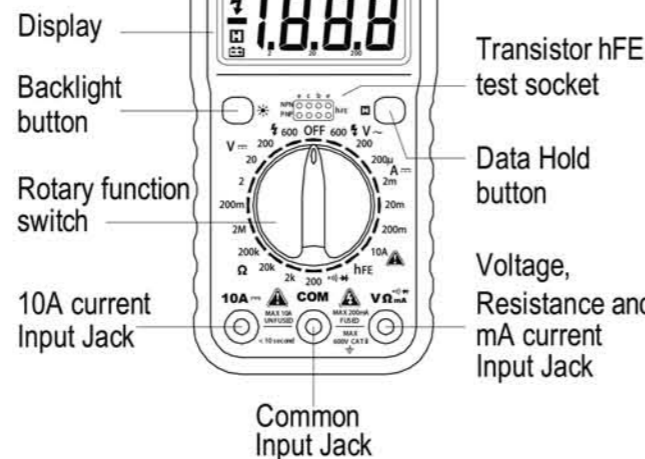

o)) Continuity Test

- 1) Connect the RED test lead into INPUT input jack and BLACK test lead into COM input jack.
- 2) Rotate the function switch to o)) position and press SEL to select o)) continuity test mode.
- 3) Connect the test leads to the object being measured. The buzzer sounds with red alarm indication light on if the resistance of a circuit under test is less than or equal to 100 Ω .

➔ Diode Test

- 1) Connect the RED test lead into INPUT input jack and BLACK test lead into COM input jack.
- 2) Rotate the function switch to ➔ position and press SEL to select ➔ diode test mode.
- 3) Connect the RED test lead to positive(+) polarity of diode under test and BLACK test lead connect to negative(-) polarity of diode under test.
- 4) Read the approx. forward voltage of the diode from the display. Test condition: open voltage is approx. 1.5V. For Si diode this voltage is about 400 ~ 1000mV.



**Caution**  
If the diode damaged or reverse connection, it will show "OL" on the display.





## Oil Can

### ★ INTRODUCTION

- Environmental-friendly PET oiler
- Flexible metal spout
- With durable brass pump for long reliable use

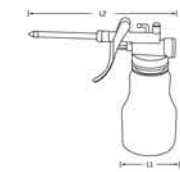

ITEMNO	SIZE(mi)	L1(mm)	L2(mm)	W(mm)	PCS	BARCODE
670002	250	65	170	160	120	6959820845015

## Pump Oil Can

### ★ INTRODUCTION

- High quality rust resistant steel construction
- Flexible metal spout
- With durable brass pump for long reliable use



ITEMNO	SIZE(mi)	L1(mm)	L2(mm)	W(mm)	PCS	BARCODE
670003	300	60	170	145	120	6959820845022

## Pump Oil Can

### ★ INTRODUCTION

- High quality rust resistant steel construction
- Flexible metal spout for those hard to reach areas
- With durable brass pump for long reliable use



ITEMNO	SIZE(mi)	L1(mm)	L2(mm)	W(mm)	PCS	BARCODE
670004	350	80	200	160	60	6959820845039

## Handles high pressure oil can

### ★ INTRODUCTION

- High quality rust resistant steel construction
- Flexible metal spout
- With durable brass pump for long reliable use

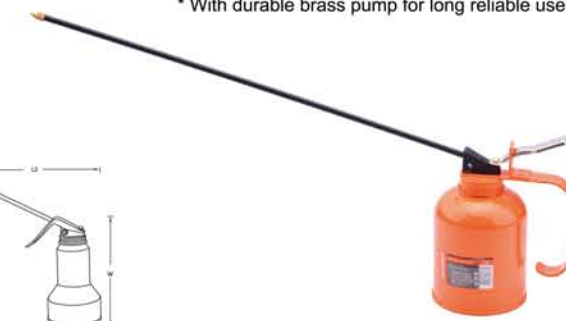

ITEMNO	SIZE(mi)	L1(mm)	L2(mm)	W(mm)	PCS	BARCODE
670005	500	90	500	145	60	6959820848634

## Pro Grease Gun

### ★ INTRODUCTION

- Heavy duty cast head construction for maximum durability and longer service life
- Durable follower rod and spring for consistent priming
- Ergonomic lever grip

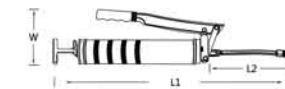

ITEMNO	SIZE(cc)	L1(mm)	L2(mm)	W(mm)	PCS	BARCODE
670101	500	710	300	130	10	6959820845046

## Grease Coupler

### ★ INTRODUCTION

- Built-in ball check prevents leak and lubricant backup
- It could be used in conjunction with HARDEN #670101, #670110



ITEMNO	L(mm)	W(mm)	PCS	BARCODE
670107	39.3	18	500	6959820845077

Grease Flexible Hose

★ INTRODUCTION

- \* Heavy duty flexible nylon hose
- \* It could be used in conjunction with HARDEN #670101



ITEMNO	SIZE(mm)	L(mm)	W(mm)	PCS	BARCODE
670108	300	252	7.9	500	6959820845084

Auto Circuit Tester

★ INTRODUCTION

- \* 6-12-24Volt system
- \* 2 extra bulbs
- \* Insulated alligator clip
- \* 1 probe cap
- \* Super sharp probe



ITEMNO	SIZE	PCS	BARCODE
670121	6V/12V/24V	120	6959820845091

Y-type Wrench

★ INTRODUCTION

- \* Y-Type Wrench
- \* Forged from high performance chrome vanadium steel
- \* Heat treated, chrome plated



ITEMNO	SIZE(mm)	L(mm)	PCS	BARCODE
670221	8x9x10	250	60	6959820845213
670222	8x10x12	250	60	6959820845220
670223	10x12x14	250	60	6959820845237
670225	12x14x17	250	60	6959820845244
670226	14x17x19	250	60	6959820845251

Grease Hard Hose

★ INTRODUCTION

- \* Heavy duty hard hose
- \* It could be used in conjunction with HARDEN #670101



ITEMNO	SIZE(mm)	L(mm)	W(mm)	PCS	BARCODE
670109	160	160	7.9	500	6959820845565

T-type Crv Wrench

★ INTRODUCTION

- \* Forged from high performance chrome vanadium steel
- \* Heat treated, chrome plated



CHROME PLATED AND QUENCHED FOR DURABILITY

ITEMNO	SIZE(mm)	L(mm)	W(mm)	PCS	BARCODE
670201	6	300	190	75	6959820845107
670202	7	300	190	75	6959820845114
670203	8	300	190	75	6959820845121
670205	9	300	190	75	6959820845138
670206	10	300	190	75	6959820845145
670207	12	300	190	75	6959820845152
670208	13	300	190	75	6959820845169
670209	14	300	190	75	6959820845176
670210	17	300	190	60	6959820845183
670211	19	300	190	60	6959820845190

Cross Wrench

★ INTRODUCTION

- \* Made from high quality Chrome Vanadium steel
- \* Chrome plated and quenched
- \* Size: 17/19/21mm, Dr.1/2"
- \* It could be used in conjunction with sockets and extension bar



ITEMNO	SIZE(mm)	L(mm)	PCS	BARCODE
670218	350	350	10	6959820845206
670219	450	450	12	6959820845572

Oil Fitter Wrench

★ INTRODUCTION

- \* Medium carbon steel
- \* Black finish head surface
- \* Adjustable for most filters



ITEM NO	SIZE	L mm	PCS	BARCODE
670310	65-75mm	235mm	50	6959820852099
670311	75-95mm	255mm	50	6959820852105

L-type Crv Wrench

★ INTRODUCTION

- \* Forged Cr-V steel
- \* Heat treated, chrome plated
- \* Equipped with 17/19mm, 21/23mm socket head
- \* The telescopic range is 345-530mm



ITEMNO	SIZE(mm)	L1(mm)	L2(mm)	W(mm)	PCS	BARCODE
670231	17x19 21x23	300	100	31	15	6959820845268

Torque Wrench

★ INTRODUCTION

- \* Made from high quality Cr-V steel, with super toughness and torsional stress
- \* Atomized spraying surface, more comfortable and durable



ITEMNO	SIZE	L(mm)	PCS	BARCODE
670235	0-300N.m	480	20	6959820835344

Oil Filter Wrench

★ INTRODUCTION

- \* Forged high quality steel
- \* Heat treated
- \* Work range:63.5mm to 116mm, adjustable for most filters



ITEMNO	L1(mm)	L2(mm)	W(mm)	PCS	BARCODE
670312	300	84	70	36	6959820845305

**Tire Pressure Gauge**

★ **INTRODUCTION**



- \* Aluminum alloy body
- \* Professional dial plate, plastic cover, ensured accuracy
- \* Degree scope: 0-200psi



ITEMNO	L(mm)	PCS	BARCODE
670506	150	40	6959820845312

**Magnetic-tray**

★ **INTRODUCTION**



- \* High quality stainless steel tray with strong magnetism
- \* Easy for collecting small parts while repairing



ITEMNO	SIZE(mm)	L(mm)	W(mm)	PCS	BARCODE
670602	225x138	225	138	24	6959820845343

**T Universal Spark Plug Socket Wrench**

★ **INTRODUCTION**



- \* Chrome Vanadium socket
- \* Heat treated spring
- \* Comfortable dipped handle



ITEMNO	SIZE(mm)	L(mm)	W(mm)	PCS	BARCODE
670931	16	250	95	60	6959820845541
670932	21	250	95	60	6959820845558

**Air Blow Gun**

★ **INTRODUCTION**



- \* Cast high quality stainless steel nozzle, strong corrosion resistance
- \* Brass inlet connector, strong and durable
- \* Effectively blowing off dust and water
- \* Good mechanical strength and toughness



ITEMNO	SIZE(mm)	L1(mm)	L2(mm)	PCS	BARCODE
671003	110	245	100	100	6959820847125
671004	300	430	285	100	6959820847132

**Magnetic-tray**

★ **INTRODUCTION**



- \* High quality stainless steel tray with strong magnetism
- \* Easy for collecting small parts while repairing



ITEMNO	SIZE(mm)	L(mm)	W(mm)	PCS	BARCODE
670601	150	150	150	24	6959820845336

**Dual Filter Wrench**

★ **INTRODUCTION**



- \* 1/2" square drive
- \* For dismantling filter within 102mm
- \* Good quality for durable use



ITEMNO	L(mm)	W(mm)	PCS	BARCODE
670911	60	85	36	6959820845442

**Air Blow Gun**

★ **INTRODUCTION**



- \* Cast high quality stainless steel nozzle, strong corrosion resistance
- \* Effectively blowing off dust and water
- \* Good mechanical strength and toughness



ITEMNO	SIZE(mm)	L1(mm)	L2(mm)	PCS	BARCODE
671001	110	230	107	100	6959820847101
671002	300	415	295	100	6959820847118

**Air Blow Gun**

★ **INTRODUCTION**



- \* Cast high quality stainless steel nozzle, strong corrosion resistance
- \* Brass inlet connector, strong and durable
- \* Effectively blowing off dust and water
- \* Good mechanical strength and toughness



ITEMNO	SIZE(mm)	L1(mm)	L2(mm)	PCS	BARCODE
671005	110	247	103	100	6959820847149
671006	300	434	291	100	6959820847156

**AIR TOOLS**



**Gravity Feed Spray Gun**

★ INTRODUCTION



- Air consumption(100%):3-8CFM
- Cup size: 600ml
- Nozzle size: 1.5mm
- Fluid delivery:160-240ml/min
- Working pressure:43psi,3kg/cm2
- Weight:0.53kgs
- Air inlet:1/4"

Applications & features:

High transfer efficiency,durable and stable performance reliable choice for medium viscosity painting of middle, & prime coating on cars,machinery, furniture and etc. colors available:polished original metal color,powder coating in any colors,chrome-plated, nickel-plated, different anodized colors.



ITEMNO	SIZE	L(mm)	W1(mm)	W2(mm)	PCS	BARCODE
681006	600ML	190	30	77.5	20	6959820835245

**Suction Spray Gun**

★ INTRODUCTION



- Air consumption(100%):3-8CFM
- Cup size: 1000ml
- Nozzle size: 1.5mm
- Fluid delivery:130-210ml/min
- Working pressure:50psi,3.5kg/cm2
- Weight:0.6kgs
- Air inlet:1/4"

Applications & features:

High transfer efficiency,durable and stable performance reliable choice for medium viscosity painting of middle, & prime coating on cars,machinery, furniture and etc. colors available:polished original metal color,powder coating in any colors,chrome-plated, nickel-plated, different anodized colors.



ITEMNO	SIZE	L(mm)	W1(mm)	W2(mm)	PCS	BARCODE
681010	1000ML	170	270	110	10	6959820835252

**Spray Gun**

★ INTRODUCTION



- Air consumption(100%):6-10CFM
- Cup size: 1000ml
- Nozzle size: 1.2mm
- Fluid delivery:130-210ml/min
- Working pressure:43psi,3kg/cm2
- Weight:0.55kgs
- Air inlet:1/4"



ITEMNO	SIZE	L(mm)	W(mm)	PCS	BARCODE
620520	1000ML	200	160	20	6959820835269

# HYDRAULIC TOOLS



**Hydraulic Floor Jack**

★ INTRODUCTION



- \*GS approved
- \*Steel plate bottle, cast iron base
- \*Min Height: 158mm
- \*Lift Height: 90mm
- \*Weight: 2.3kgs
- \*Adjustable Height: 50mm
- \*Preventing from oil leakage
- \*Oil remaining clear after using
- \*Packing: plastic case

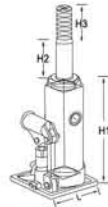

ITEMNO	SIZE	WEIGHT	L(mm)	H1(mm)	H2(mm)	H(mm)	PCS	BARCODE
730102	2 T	2.3kg	95	158	90	50	10	6959820853706
730104	4T	3.2kg	105	180	110	50	5	6959820853713
730106	6T	4.0kg	115	200	125	60	5	6959820853720
730110	10T	5.3kg	125	200	125	60	4	6959820853737
730120	20T	9.8kg	165	235	145	60	2	6959820853744
730150	50T	26kg	175	260	180	0	1	6959820853755

**HAND OPERATED VERTICAL HYDRAULIC JACK**

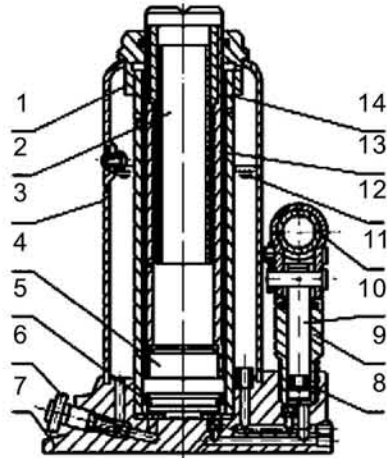

1. Top cap
2. Adjusting screw
3. Oil tight tank
4. Ram head
5. Circle seal
6. Release valve
7. Base
8. Circle seal
9. Pump body
10. Pump plunger
11. Push handle
12. Hydraulic oil
13. Ram
14. Cylin

1. Before operating, estimate the weight of the load. Do not overload the jack beyond its rated load.
2. Select point of action according to the gravitational center place the jack on the hard ground if necessary. Place a hard plank under the jack to avoid tottering or falling during operation.
3. Before operating the jacks, first insert the notched end of the handle into the release valve. Turn the operating handle clockwise until release valve is closed. Do not over tighten the valve.
4. Insert operating handle into the socket and the ram is steadily raised by the up and down movement of the handle and the load is raised. The ram will stop rising when the required height is reached
5. Lower the ram by turning the release valve Counter-clockwise with the notched end slacken it slowly when a load is applied or accidents can occur.
6. When more than one jack is used at the same time, it is important to keep the all jacks at an equal speed with equal load. Otherwise, there is danger of falling the entire fixture.
7. At the temperature from 27F to 113F, use machine oil (GB443-84)N15, At the temperature from -4F to 27F, use synthetic spindle oil (GB442-64), Sufficient filtered hydraulic oil should be maintained in the jacks. Otherwise, the rated height can not be reached
8. Violent shocks must be avoided during the operation
9. User must operate the jack correctly according to operating instruction. If the jack has some quality problem, it can not be operated

**2Ton Hydraulic Trolley Jack**

★ INTRODUCTION



- \*GS approved
- \*Weight: 8.5Kgs
- \*Min height: 125mm
- \*Max height: 330mm
- \*Packing: plastic case



ITEMNO	SIZE	WEIGHT	L(mm)	H1(mm)	H2(mm)	PCS	BARCODE
730202	2T	8.5kg	440	125	330	1	6959820853768

**3Ton Hydraulic Trolley Jack**

★ INTRODUCTION



- \*GS approved
- \*Heavy duty 34Kgs
- \*Min height: 75mm
- \*Max height: 500mm
- \*Fast lifting dual pump
- \*Packing: color box

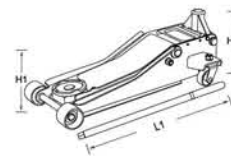

ITEMNO	SIZE	WEIGHT	L(mm)	H1(mm)	H2(mm)	PCS	BARCODE
730213	3T	34kg	670	75	500	1	6959820853775

**POWER TOOLS**



**10mm Electric Drill**

★ INTRODUCTION



- \* Frequency: 50/60HZ
- \* Rated Power: 450 W
- \* No-load speed: 3300r/min
- \* Chuck size: 10mm
- \* Max in Wood: 15mm
- \* Max in steel: 10mm
- \* Packed by color box



ITEMNO	SIZE	VOITAGE	PCS	BARCODE
750I41	450W	110V	10	6959820851053
750I42	450W	220V	10	6959820851053

**13mm Impact Drill**

★ INTRODUCTION



- \* Frequency: 50/60HZ
- \* Rated Power: 710 W
- \* No-load speed: 2800r/min
- \* Chuck size: 13mm
- \* Max in wood: 25mm
- \* Max in concrete: 16mm
- \* Max in steel: 13mm
- \* Accessories container: 1pc side handle  
1pc 13mm key chuck ,1pc depth guage



ITEMNO	SIZE	VOITAGE	PCS	BARCODE
750I71	710W	110V	10	6959820851047
750I72	710W	220V	10	6959820851047

**13mm Impact Drill**

★ INTRODUCTION



- \* Frequency: 50/60HZ
- \* Rated Power: 850 W
- \* No-load speed: 3200r/min
- \* Chuck size: 13mm
- \* Max in wood: 30mm
- \* Max in concrete: 16mm
- \* Max in steel: 13mm
- \* Accessories container: 1pc side handle  
1pc 13mm key chuck ,1pc depth guage,  
1couple carbon brush



ITEMNO	SIZE	VOITAGE	PCS	BARCODE
750I81	850W	110V	5	6959820851061
750I82	850W	220V	5	6959820851061

**26mm Rotary Hammer**

★ INTRODUCTION



- \* Frequency: 50/60HZ
- \* Rated Power: 800 W
- \* No-load speed: 1180r/min
- \* Impact rate: 0-4600r/min
- \* Impact energy: 3J
- \* Max in wood: 30mm
- \* Max in concrete: 26mm
- \* Max in steel: 13mm
- \* SDS plus chuck system
- \* Accessories container: 2 drills and 2 chisels,  
1pc depth guage
- \* Packed by BMC.



ITEMNO	SIZE	VOITAGE	PCS	BARCODE
750381	800W	110V	5	6959820851078
750382	800W	220V	5	6959820851078

**26mm Rotary Hammer**

★ INTRODUCTION



- \* Frequency: 50/60HZ
- \* Rated power: 900 W
- \* No-load speed: 950r/min
- \* Impact rate: 0-4600r/min
- \* Max in wood: 40mm
- \* Max in concrete: 28mm
- \* Max in steel: 13mm
- \* SDS plus chuck system
- \* Accessories container: 2 drills and 2 chisels
- \* Packed by BMC



ITEMNO	SIZE	VOITAGE	PCS	BARCODE
750621	900W	110V	3	6959820851085
750622	900W	220V	3	6959820851085

**35mm Demolition Breaker**

★ INTRODUCTION



- \* Frequency: 50/60HZ
- \* Rated power: 1100 W
- \* Impact rate: 0-3200r/min
- \* Impact energy: 12J
- \* Hex-Gan
- \* Accessories container: 1pc point chisel 17x280mm,  
1pc flat chisel -17x280mm, 1couple carbon brush,  
1pc oil box. 1pc spanner, 1pc inner hexagan spanner
- \* Packed by BMC



ITEMNO	SIZE	VOITAGE	PCS	BARCODE
750811	1100W	110V	3	6959820845046
750812	1100W	220V	3	6959820845046

**28mm Rotary Hammer**

★ INTRODUCTION



- \* Frequency: 50/60HZ
- \* Rated power: 1050 W
- \* No-load speed: 950r/min
- \* Impact rate: 0-4600r/min
- \* Max in wood: 40mm
- \* Max in concrete: 28mm
- \* Max in steel: 13mm
- \* SDS plus chuck system
- \* Accessories container: 2 drills and 2 chisels
- \* Packed by BMC



ITEMNO	SIZE	VOITAGE	PCS	BARCODE
750631	1050W	110V	3	6959820851092
750632	1050W	220V	3	6959820851092

**13mm Electric Drill**

★ INTRODUCTION



- \* Frequency: 50/60HZ
- \* Rated power: 1400 W
- \* Impact rate: 0-1800r/min
- \* Impact energy: 45J
- \* Hex-Gan
- \* Accessories container: 1pc point chisel 30x410mm,  
1pc flat chisel 30x410mm, 1couple carbon brush,  
1pc oil box, 1pc spanner, 2pc inner hexagan spanner
- \* Packed by Metal Box



ITEMNO	SIZE	VOITAGE	PCS	BARCODE
750831	1400W	110V	1	6959820851115
750832	1400W	220V	1	6959820851115

**100mm Angle Grinder**

★ INTRODUCTION



- \* Frequency: 50/60HZ
- \* Rated power: 750W
- \* No-load speed: 11000r/min
- \* Max disc diameter: 100mm
- \* Spindle thread: M10
- \* Accessories container: 1pc side handle  
1pc disc guard, 1pc wrench, 1couple carbon brush
- \* Packed by color box



ITEMNO	SIZE	VOITAGE	PCS	BARCODE
75IO11	750W	110V	10	6959820851122
75IO12	750W	220V	10	6959820851122

**100mm Angle Grinder**

★ INTRODUCTION



- \* Frequency: 50/60HZ
- \* Power: 750 W
- \* No-load speed: 11000r/min
- \* Max disc diameter: 100mm
- \* Spindle thread: M14
- \* Accessories container: 1pc side handle  
1pc disc guard, 1pc wrench, 1couple carbon brush
- \* Packed by color box



ITEMNO	SIZE	VOITAGE	PCS	BARCODE
75IO51	750W	110V	10	6959820851146
75IO52	750W	220V	10	6959820851146

**125mm Angle Grinder**

★ INTRODUCTION



- \* Frequency: 50/60HZ
- \* Rated power: 850W
- \* No-load speed: 10800r/min
- \* Max disc diameter: 115mm/125mm
- \* Spindle thread: M14
- \* Accessories container: 1pc side handle  
1pc disc guard, 1pc wrench, 1couple carbon brush
- \* Packed by color box



ITEMNO	SIZE	VOITAGE	PCS	BARCODE
75IO31	850W	110V	10	6959820851139
75IO32	850W	220V	10	6959820851139

**230mm Angle Grinder**

★ INTRODUCTION



- \* Frequency: 50/60HZ
- \* Rated power: 2200W
- \* No-load speed: 6000r/min
- \* Max disc diameter: 230mm
- \* Spindle thread: M14
- \* Accessories container: 1pc side handle  
1pc disc guard, 1pc wrench, 1couple carbon brush
- \* Packed by color box



ITEMNO	SIZE	VOITAGE	PCS	BARCODE
75IO81	2200W	110V	4	6959820851153
75IO82	2200W	220V	4	6959820851153

**180mm Angle Polisher**

★ INTRODUCTION



- \* Frequency: 50/60HZ
- \* Rated power: 1200W
- \* No-load speed: 3000r/min
- \* Polishing pad diameter: 180mm
- \* Spindle thread: M14
- \* Accessories in color box:  
1couple carbon brush  
1pc polishing pad  
1pc wool wheel  
1pc handle  
2pcs screws  
1pc hexagon wrench



ITEMNO	SIZE	VOITAGE	PCS	BARCODE
75III1	1200W	110V	4	6959820851160
75III2	1200W	220V	4	6959820851160

**185mm Circular Saw**

★ INTRODUCTION



- \* Frequency: 50/60HZ
- \* Rated power: 1250W
- \* No-load speed: 6000rpm
- \* Diameter of blade: 185x22.2mm
- \* Max cutting capacity: 45 degree:32mm 90 degree:58mm
- \* Adjustable cutting depth
- \* Accessories container:  
1pc wrench  
1couple carbon brush  
1pc user manual
- \* Packed by color box



ITEMNO	SIZE	VOITAGE	PCS	BARCODE
75I521	1250W	110V	4	6959820851184
75I522	1250W	220V	4	6959820851184

**110mm Marble Cutter**

★ INTRODUCTION



- \* Frequency: 50/60HZ
- \* Rated power: 1250W
- \* No-load speed: 12500rpm
- \* Diameter of blade: 110x20mm
- \* Max cutting capacity: 32mm
- \* Adjustable cutting depth
- \* Accessories container:  
1pc user manual  
1pc wrench  
1couple carbon brush
- \* Packed by color box



ITEMNO	SIZE	VOITAGE	PCS	BARCODE
75I511	1250W	110V	4	6959820851177
75I512	1250W	220V	4	6959820851177

**235mm Circular Saw**

★ INTRODUCTION



- \* Frequency: 50/60HZ
- \* Rated power: 2300W
- \* No-load speed: 4000rpm
- \* Diameter of blade: 235x25.4mm
- \* Max cutting capacity: 45 degree:65mm 90 degree:84mm
- \* Adjustable cutting depth
- \* Accessories container:  
1pc wrench  
1couple carbon brush  
1pc user manual
- \* Packed by color box



ITEMNO	SIZE	VOITAGE	PCS	BARCODE
75I531	2300W	110V	2	6959820851197
75I532	2300W	220V	2	6959820851197

255mm Mitre Saw

★ INTRODUCTION



- \* Frequency: 50/60HZ
- \* Rated power: 1350W
- \* No load speed: 6000rpm
- \* Blade size: 255mm\*25.4mm
- \* Copper wire induction motor
- \* Aluminum base
- \* Max. cutting capacity: 0 degree :80\*90mm(H\*W) 45 degree :80\*80mm(H\*W)
- \* Dust bag keep work area clean
- \* Accessories container: 1couple carbon brush, 1pc dust bag, 1pc wrench, 1pc user manual
- \* Packed by color box



ITEMNO	SIZE	VOITAGE	PCS	BARCODE
753521	1350W	110V	1	6959820851207
753522	1350W	220V	1	6959820851207

355mm Cut Off Saw

★ INTRODUCTION



- \* Frequency: 50/60HZ
- \* Rated power: 2700W
- \* Blade size: 355x25.4mm
- \* No-load speed: 3900rpm
- \* Max cutting capacity: Solid steel pipe:58mm, Hollow steel pipe:110mm, Rectangle: 110\*130mm
- \* With 1pc 355mm cutting disc
- \* Accessories container: 1pc wrench, 1couple carbon brush, 1pc user manual



ITEMNO	SIZE	VOITAGE	PCS	BARCODE
753551	2700W	110V	1	6959820851214
753522	2700W	220V	1	6959820851214

Electric Jig Saw

★ INTRODUCTION



- \* Frequency: 50/60HZ
- \* Rated power: 570W
- \* No-load speed: 800-3000rpm
- \* Capacity wood: 65mm
- \* Capacity steel: 6mm
- \* Accessories container: 1couple carbon brush, 11pc hexagon wrench, 1pc saw blade for wood, 1pc dust tube
- \* Packed by color box



ITEMNO	SIZE	VOITAGE	PCS	BARCODE
752651	570W	110V	10	6959820851221
752652	570W	220V	10	6959820851221

Reciprocating Saw

★ INTRODUCTION



- \* Frequency: 50/60HZ
- \* Rated power: 710W
- \* No-load Speed: 2800rpm
- \* Rotatable handle
- \* Accessories container: 1couple carbon brush, 1pc saw blade for wood
- \* Packed by color box



ITEM NO	SIZE	VOITAGE	PCS	BARCODE
752671	710W	110V	2	6959820852112
752672	710W	220V	2	6959820852112

Electric Planner

★ INTRODUCTION



- \* Frequency: 50/60HZ
- \* Rated power: 850W
- \* No-load Speed: 17000r/min
- \* Width of Cutter: 82mm
- \* Cut-depth: 2.5mm
- \* Accessories container: 1pc collect bag, 3pcs levels, 1pc hex key, 1pc wrench, 2pc screws, 4pc flat washers
- \* Packed by color box



ITEMNO	SIZE	VOITAGE	PCS	BARCODE
752701	650W	110V	6	6959820851283
752702	650W	220V	6	6959820851283

110x110mm Finish sander

★ INTRODUCTION



- \* Frequency: 50/60HZ
- \* Rated power: 200W
- \* No-load speed: 15.000min<sup>1</sup> /30.000min<sup>1</sup>
- \* Pad size: 110x100mm
- \* Packed by color box



ITEMNO	SIZE	VOITAGE	PCS	BARCODE
752721	200W	110V	10	6959820851276
752722	200W	220V	10	6959820851276

Electric Router

★ INTRODUCTION



- \* frequency: 50/60HZ
- \* Rated power: 1400W
- \* No-load Speed: 24000r/min
- \* Chuck Diameter: 12mm
- \* Accessories container: 1pc guide rod, 1pc guide rod plate, 1pc chuck, 1pc horizontal guide, 1pc rail, 1pc linear guideway, 1pc 24 wrench, 1pc 17 wrench
- \* Packed by color box



ITEMNO	SIZE	VOITAGE	PCS	BARCODE
752711	1400W	110V	4	6959820851245
752712	1400W	220V	4	6959820851245

Electric Trimmer

★ INTRODUCTION



- \* Frequency: 50/60HZ
- \* Rated power: 300W
- \* No-load Speed: 33000r/min
- \* Collet Chuck Diameter: 6mm
- \* Accessories container: 1pc guide wheel, 1pc Small iron, 1pc Aluminum guide, 1pc wheel frame, 1pc Horizontal guide, 1pc rail, 1pc linear guideway, 1pc dust cover, 1pc 17 wrench, 1pc 10 wrench
- \* Packed by color box



ITEMNO	SIZE	VOITAGE	PCS	BARCODE
752731	300W	110V	10	6959820851252
752732	300W	220V	10	6959820851252



**Aspirator blower**

★ INTRODUCTION



- \* Voltage: 110V/220-240V
- \* Frequency: 50/60HZ
- \* Rated power: 425W
- \* No-load speed: 13000rpm
- \* Max. blowing rate: 2.3m<sup>3</sup> /min
- \* Packed by color box
- \* Accessories container:
  - 1 couple carbon brush
  - 1pc blower pipe
  - 1pc ring
  - 1pc dust bag
- \* Packed by color box



ITEMNO	SIZE	VOITAGE	PCS	BARCODE
752801	425W	110V	12	6959820851269
752802	425W	220V	12	6959820851269

**Cordless Drill**

★ INTRODUCTION



- \* Voltage: 16V
- \* Speed: 0-400/1450r/min
- \* Battery: Lithium
- \* Battery capacity: 1500mAh
- \* Chuck size: 0.8-10mm
- \* Charge time: 1Hour
- \* 2Pcs batteries \* 1Pc battery charger
- \* Accessories container: 10pcs 25mm screwdriver bits, 1pc bit holder, 2pcs drill for metal, 1pc 6mm drill for masonry, 1pc 6mm drill for tile, 1pc 110mm philips bits
- \* Packed by BMC



ITEMNO	SIZE	PCS	BARCODE
756116	110V charger	10	6959820850965

**Cordless Drill**

★ INTRODUCTION



- \* Voltage: 12V
- \* Speed: 0-350/1350r/min
- \* Battery: Lithium
- \* Battery capacity: 1500mAh
- \* Chuck size: 0.8-10mm
- \* Charge time: 1Hour
- \* 1Pc battery \* 1Pc battery charger \* Packed by color box



ITEMNO	SIZE	PCS	BARCODE
756012	110V charger	10	6959820851276

**Cordless impact drill**

★ INTRODUCTION



- \* Voltage: 21V
- \* No\*load speed: 0-1800r/min
- \* Battery : 2000mAh
- \* Impacts per Minute: 0-3200IPM
- \* Holding ability: 1-13mm
- \* Max torque: 70N.m
- \* Packed by BMC



ITEMNO	SIZE	PCS	BARCODE
756121	21V	10	6959820853140

**Cordless Rotary Hammer**

★ INTRODUCTION



- \* Voltage: 21V
- \* Speed: 0-1300/min
- \* Battery : 3000-6000mAh
- \* Drill Ability: 16mm(5/8")
- \* Impact energy: 1.3J
- \* Packed by BMC



ITEMNO	SIZE	PCS	BARCODE
756221	21V	5	6959820853157

**Cordless Impact Wrench**

★ INTRODUCTION



- \* Voltage: 21V
- \* Speed: 0-2400/min
- \* Impact times : 0-2800IPM
- \* Battery : 2000mAh
- \* Output shaft: 12.7mm(1/2")
- \* Max torque: 250N.m
- \* Packed by BMC



ITEMNO	SIZE	PCS	BARCODE
756521	21V	5	6959820853164

**Cordless Caulking Gun**

★ INTRODUCTION



- \* Voltage: 21V
- \* Press Out Speed: 0-8.7mm/s
- \* Battery : 2000mAh
- \* Max Pressare force: 6500N
- \* Material Capacity: 300/600ML
- \* Packed by BMC



ITEMNO	SIZE	PCS	BARCODE
757321	21V	4	6959820853188

**Cordless Angle grinder**

★ INTRODUCTION



- \* Voltage: 21V
- \* Speed: 0-7500/min
- \* Battery : 3000mAh
- \* Max Disc Diameter : 100/115/125mm
- \* Spindle thread: M10/M14
- \* Max torque: 120-320N.m
- \* Packed by BMC



ITEMNO	SIZE	PCS	BARCODE
757021	21V	5	6959820853171

**Cordless Bower**

★ INTRODUCTION



- \* Voltage: 16V
- \* No\*load speed: 0-1500r/min
- \* Battery : 1500mAh
- \* Max air speed: 130Kmh
- \* Max air volume: 60CFM



ITEMNO	SIZE	PCS	BARCODE
758016	16V	10	6959820853195

**SAFETY PRODUCTS**



**2Pcs Dust Mask Set**

★ INTRODUCTION



- \*EN149:2001+A1:2009
- \*CE certificate
- \*FFP2 NR
- \*With valve
- \*With rubber belt
- \*Aluminum nose clip
- \*Exhalation valve offers easier breathing in hot, humid conditions
- \*Adjustable nose clip offers a secure fit and reduces fogging
- \*Disposable, lightweight, comfortable wear, and economical
- \*Applications for grinding, sanding, and sweeping jobs

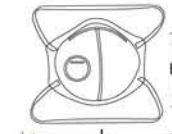

ITEM NO	SIZE	L mm	H mm	PCS	BARCODE
780112	140mm	155mm	50mm	100	6959820852839

**Safety Goggle**

★ INTRODUCTION



- \*CE approved
- \*Full view design
- \*Impact resistant
- \*Fit to wearing the corrective glasses, also as visitors glasses.
- \*Defend against splash particles around



ITEM NO	SIZE	L mm	H mm	PCS	BARCODE
780202	140mm	160mm	60mm	200	6959820852846

**Safety Goggle**

★ INTRODUCTION



- \*CE approved
- \*Impact resistant
- \*Soft and light weight plastic frame with vent-holes
- \*High-impact polycarbonate lenses, transparency comfortable for wearing

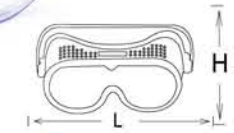

ITEM NO	SIZE	L mm	H mm	PCS	BARCODE
780205	160mm	180mm	70mm	100	6959820852808

**Safety Goggle**

★ INTRODUCTION



- \*CE approved
- \*Impact resistant polycarbonate, clear distortion free viewing
- \*Adjustable leg of frame for comfortable use and fit

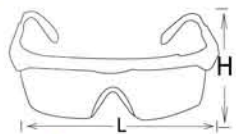

ITEM NO	SIZE	L mm	H mm	PCS	BARCODE
780201	140mm	155mm	50mm	200	6959820852839

**Safety Goggle**

★ INTRODUCTION



- \*CE approved
- \*Impact resistant polycarbonate, clear distortion free viewing
- \*Light weight, comfortable to wear, wide visual field



ITEM NO	SIZE	L mm	H mm	PCS	BARCODE
780203	130mm	140mm	45mm	200	6959820852853

**Safety Goggle**

★ INTRODUCTION



- \*Flip design with open-close locking position
- \*Soft and light weight plastic frame
- \*Colored inorganic outer glass lens
- \*Transparent clear inner glass lens

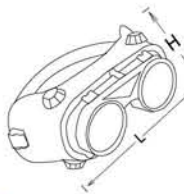

ITEM NO	SIZE	L mm	H mm	PCS	BARCODE
780210	155mm	190mm	85mm	100	6959820852815

